



Antenna Fundamentals

Santa Clara County ARES®/RACES
Last Updated September 04, 2023

ARES and Amateur Radio Emergency Service are registered service marks of the American Radio Relay League Incorporated and are used by permission.

Copyright 2023 Santa Clara County ARES®/RACES. All rights reserved.

1

1

USE AND DISTRIBUTION NOTICE

- Santa Clara County ARES®/RACES authorization is granted to use and duplicate this material as-is, as long as this page and the copyright notices on each page are included, acknowledging Santa Clara County ARES/RACES as the holder of the copyright.
- Permission is granted to adapt this presentation to your needs as long as you acknowledge our copyright and include a note similar to "adapted with permission from Santa Clara County ARES®/RACES"
- For additional information on training or any of our programs send an email to: info@scc-ares-races.org

Copyright 2023 Santa Clara County ARES®/RACES. All rights reserved.

2

2

HOUSEKEEPING

- Introductions
- Pen/pencil & paper
- Cell phones
- Side conversations
- Questions
- Breaks
- Restrooms
- In case of emergency
- Security and COVID-19 protocol; stay in this area of the building.

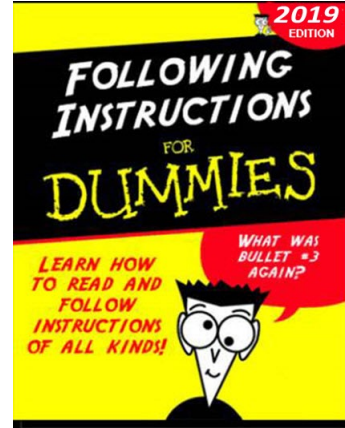

Copyright 2023 Santa Clara County ARES®/RACES. All rights reserved.

3 3

3

Final Assignment

Please complete the course evaluation within one-week.

To get course credit you need to:

- Attend at least 90% of the class
- Participate in class discussion
- Complete the on-line class evaluation

If you do these, you will get credit for the course.

Recommendation:

conduct an RF Safety Evaluation of your station(s), print to PDF and archive them

Copyright 2023 Santa Clara County ARES®/RACES. All rights reserved.

4

4

Online Class Evaluation

LOG INTO [HTTPS://WWW.SCC-ARES-RACES.ORG/ACTIVITIES/EVENTS.PHP](https://www.scc-ares-races.org/activities/events.php)

CLICK "SUBMIT CLASS EVALUATION" IN EVENTS

The screenshot shows the website's navigation menu on the left with a red arrow pointing to the 'Submit Class Evaluation' link. The main content area features a 'Calendar of Events' section with a table of events. The first event listed is 'Training Net - Message Passing Practice' on 02/16/21 at 8:30 PM. Below it is a description: 'This is the monthly Message Passing Training Net held on the third Tuesday of each month. The training net will be held on the Resource Net ...'. The second event listed is 'ARES/RACES Communications Drill - CITY participation'.

5

Agenda

The Radio Communications Circuit

- Propagation
- Antenna
- Coax Cable
- Radio



Putting It All Together

Note: Focus is on VHF, UHF and HF practices for local/regional emergency communications

Copyright 2023 Santa Clara County ARES®/RACES. All rights reserved.

6

6

Sidebar: What is HF/VHF/UHF?

- HF
 - 3 – 30 MHz
 - Includes 80m, 60m, 40m, 30m, 20m, 17m, 15m, 12m, 10m amateur bands
- VHF
 - 30 – 300 MHz
 - Includes 6m (50-54 MHz) 2m (144-148 MHz) and 1.25m (222-225 MHz) amateur bands
- UHF
 - 300 – 3,000 MHz
 - Includes 70cm (420-450 MHz), 33 cm (902-928 MHz) and 23cm (1240-1300 MHz) amateur bands

Copyright 2023 Santa Clara County ARES®/RACES. All rights reserved.

7

7

Sidebar: What is a decibel?

- The **decibel (dB)** is a **logarithmic** unit that indicates the **ratio** of a physical quantity (usually power) to a **specified reference level**.

$$\text{dB} = 10 \log_{10} (P_{\text{meas}}/P_{\text{ref}})$$

- 1 dB = 26% change
- 3 dB = 2 times change
- 10 dB = 10 times change
- 20 dB = 100 times change

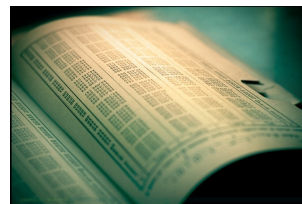

- 1 dB is the smallest change in sound detectable by an average listener

Copyright 2023 Santa Clara County ARES®/RACES. All rights reserved.

8

8

The Radio Communications Circuit

The diagram illustrates the radio communications circuit. On the left, a **Transmitting Station** (a radio with a microphone) is connected to an **Antenna** on a tripod. A green arrow labeled **Propagation** points from the antenna towards the right. In the air, there are several red lightning bolts labeled **Other Signals**. On the right, another **Antenna** on a tripod is connected to a **Receiving Radio** (a handheld radio) via a **Coax Cable**. A cartoon character of a man in a red and white striped shirt and blue pants is standing next to the receiving radio.

- Getting a signal from one radio to another involves multiple elements
 - A station to launch the signal into the “air” (radio, cable, antenna)
 - Propagation that affects the signal as it moves toward the receiving radio
 - Antenna to “capture” the signal from the “air” along with other signals
 - Cable to get the signal from the antenna to the receiving radio
 - Receiving radio to select the desired signal from all signals received by the antenna

Copyright 2023 Santa Clara County ARES®/RACES. All rights reserved. 9

9

Propagation

How the does the signal get to the other receiver?

Copyright 2023 Santa Clara County ARES®/RACES. All rights reserved. 10

10

“On a clear day, you can talk forever”

All you need to know....
Friis Transmission Formula

$$P_r = P_t G_t G_r \frac{\lambda^2}{(4 \pi r)^2}$$

This form uses “regular” numbers, not dB values

Copyright 2023 Santa Clara County ARES®/RACES. All rights reserved.

11

Friis Transmission Equation (in dB format)

$$P_r = P_t + G_t + G_r - \underbrace{20 \log_{10}(R) - 20 \log_{10}(f) - 36.56}_{\text{Free space path loss}}$$

- Where:
 - Receive & Transmit Power (P_r & P_t) are now in units of dBm or dBW
 - Receive & Transmit Antenna Gain (G_r & G_t) are in units of dBi
 - dBW in reference to 1 Watt, dBm in reference to 1 milliWatt, dBi in reference to an isotropic radiator vs. dipole dBd (see slide 29)
 - Range (R) is in units of miles (you lose 20dB every 10 miles)
 - Frequency (f) is in units of MHz (lower frequency = lower loss)
 - 36.56 is the magic number that includes all of the other constants
- These equations apply to far field, line of sight, free space only, with no obstacles nearby to cause reflection (multipath) or diffraction.
- In reality, many other factors also come into play

Copyright 2023 Santa Clara County ARES®/RACES. All rights reserved.

12

Example For Two 5w HT's

- How far can I transmit on a 5W HT @ 146 MHz?
 - Transmit power = 5W = 36.99 dBm
 - Min. receive power \approx -115 dBm (BTW, $\approx 3.15 \times 10^{-15}$ W!)
 - HT antennas = 0 dB gain (or worse!)
- Let's move some terms around

$$P_r = P_t + G_t + G_r - 20 \log_{10}(R) - 20 \log_{10}(f) - 36.56$$
 - Do some algebra to put the range term on the left side

$$\log_{10}(R) = [P_t - P_r - G_t - G_r - 20 \log_{10}(f) - 36.56]/20$$
- Now, plug in our values

$$\log_{10}(R) = [36.99 - (-115) - 0 - 0 - 43.29 - 36.56]/20$$

$$\log_{10}(R) = 3.6$$

$$R = 10^{(3.6)} = 3981 \text{ miles!}$$



But, here on Earth we face other obstacles...

Copyright 2023 Santa Clara County ARES®/RACES. All rights reserved.

13

13

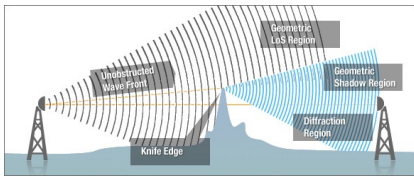
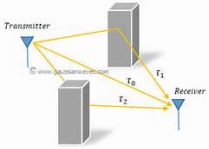
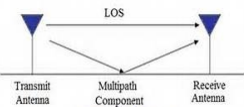
VHF/UHF Propagation Factors

- Primarily line-of-sight
 - The higher the frequency, the more this is true
- Diffraction
 
- Multi-path
 

- Curvature of the earth
 

Copyright 2023 Santa Clara County ARES®/RACES. All rights reserved.

14

14

Diffraction

- Radio waves can diffract (bend) around a sharp object (“knife edge diffraction”)

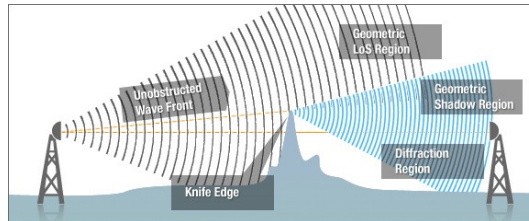

- This can redirect a signal into areas that would not be covered by direct waves (diffraction region)
- But it can distort signals where the diffracted signal collides with the direct signal (geometric shadow region)
- Avoid diffraction as much as possible by raising the antenna as high as possible

Copyright 2023 Santa Clara County ARES®/RACES. All rights reserved.

15

15

Multipath

- Signals may bounce off the ground or surrounding buildings, etc.

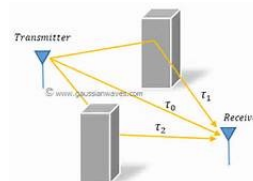
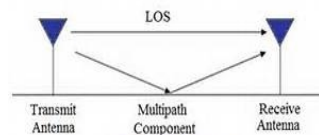

- The reflected copy of the signal will arrive at the receiver with a phase difference which depends on the path length
 - A phase difference of 0 will reinforce the signal
 - A phase difference of 180 degrees will cancel the signal!
 - Other values of phase difference can distort the signal

Copyright 2023 Santa Clara County ARES®/RACES. All rights reserved.

16

16

Multipath: Fresnel Zone

- Fresnel zones are elliptical regions around the line of sight path where objects (includes the ground) can cause multipath interference at the receiver
- Frequency dependent – the higher the frequency, the smaller the zone
- The first Fresnel zone (F1) consists of the ellipse with paths which are one half wavelength longer than the direct path

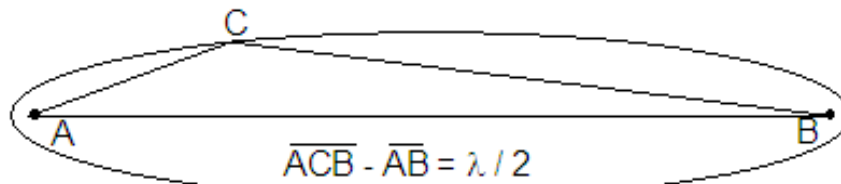

Copyright 2023 Santa Clara County ARES®/RACES. All rights reserved.

17

17

Multipath: Fresnel Zone (cont.)

- It is best to have no obstructions within the first Fresnel zone (see References for examples)

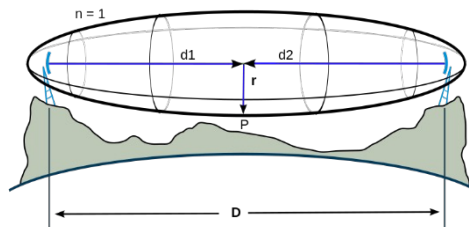

- Rule of Thumb: At least 60% of the first Fresnel zone must be clear of any obstructions in order for the radio wave propagation to behave as if it is in “free space”.

Copyright 2023 Santa Clara County ARES®/RACES. All rights reserved.

18

18

Multipath: Fresnel Zone (cont.)

- Example values for 60% F_1 mid-point radius for several end-to-end link distances:

Frequency	1 mile	2 miles	3 miles	4 miles	6 miles	8 miles
146 MHz	73 ft	103 ft	126 ft	146 ft	179 ft	207 ft
222 MHz	59 ft	84 ft	103 ft	118 ft	145 ft	168 ft
444 MHz	42 ft	59 ft	73 ft	84 ft	103 ft	118 ft

- So for a 2m antenna on a 30 ft mast, everything is in the first Fresnel Zone except close to the antenna
- Conclusion:
 - For a VHF/UHF field station, multipath is almost always present; the best we can do is try to minimize it
 - The worst interference occurs closest to the line of sight path
 - Therefore, every foot of additional clearance is helpful
 - Place the antenna as high as possible and in as clear an area as possible

Copyright 2023 Santa Clara County ARES®/RACES. All rights reserved.

19

19

Curvature of the Earth



- The curvature of the earth limits the maximum range of a line of sight signal
 - (Other obstacles may limit the range further)
- The point where the signal just touches the earth is called the Radio Horizon
- With a little geometry...
 - Distance to the Radio Horizon $\approx \sqrt{2 H(\text{ft})}$ miles
- Other propagation modes may help your signal go farther once it passes the Radio Horizon

Copyright 2023 Santa Clara County ARES®/RACES. All rights reserved.

20

20

Radio Horizon at 146 MHz

Height (ft.)	Radio Horizon (miles)	
2.5	2	Table Top
5	3	HT near your mouth
10	4	Tripod with mast
15	5	Small push up mast
30	8	Long push up mast

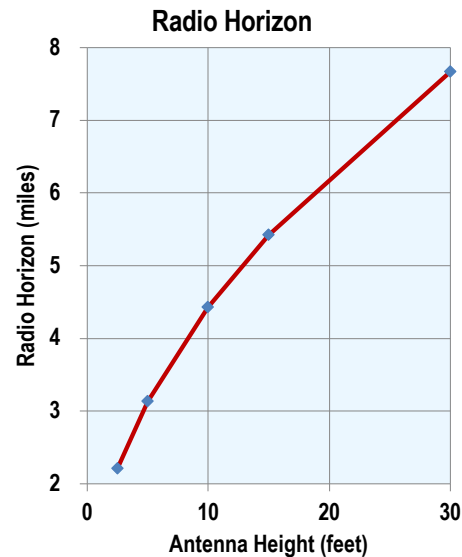

Does not include the effects of obstacles or terrain

Copyright 2023 Santa Clara County ARES®/RACES. All rights reserved.

21

21

Key Points for VHF/UHF Antennas

- A repeater up on a mountain makes things easier. But it won't always be available for a public service event or an emergency.
- Build your station expecting to use simplex
- Get your antenna up as high as possible
 - Reduces diffraction caused by ground clutter
 - Reduces multipath caused by ground clutter
 - Extends range over curvature of the earth
- A 30 foot push-up fiberglass mast and a roll-up J-pole antenna is highly portable and makes a great antenna for a field station.

Copyright 2023 Santa Clara County ARES®/RACES. All rights reserved.

22

22

HF Propagation for Emergency Communications

- “Conventional” Sky wave
 - Jargon: “Skip”, “Band Open”
 - Departure/Arrival angles 5-30 degrees
 - Maximum Usable Frequency (MUF) is the highest frequency **that provides skip**
 - Other phenomena can also provide extended signal paths
 - Creates a “Skip Zone”
 - 600 miles plus
- Near Vertical Incidence Sky wave (NVIS) reflects back down into the region around the transmitter
 - 30-400 miles
 - Critical Frequency **is the highest frequency that is reflected back from vertical incidence**
 - Typically around 5 MHz

Copyright 2023 Santa Clara County ARES®/RACES. All rights reserved.

23

23

Ionogram Shows Layers of the Ionosphere

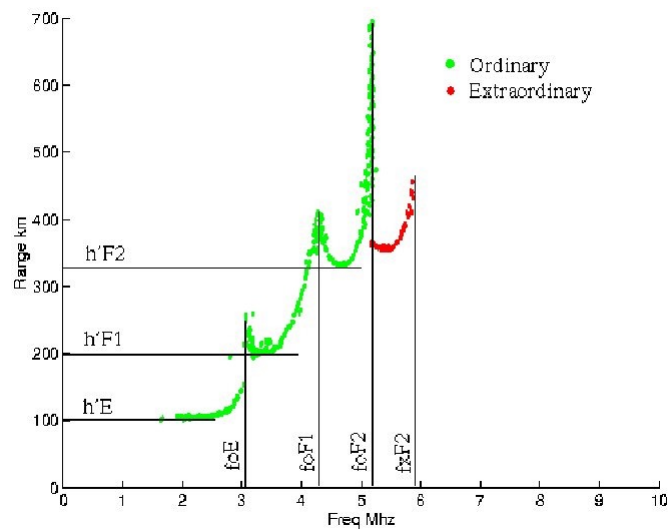

https://www.researchgate.net/publication/233988624_D42-1_OBLOQUE_IONOSPHERIC_SOUNDING_FINAL_REPORT

Copyright 2023 Santa Clara County ARES®/RACES. All rights reserved.

24

24

Antenna Height Determines Coverage

- Height = $\frac{1}{2}$ wave
- Height = $\sim .10$ wave

Copyright 2023 Santa Clara County ARES®/RACES. All rights reserved. 25

25

The Antenna

Getting the signal into and out of the air

Copyright 2023 Santa Clara County ARES®/RACES. All rights reserved. 26

26

All You Need to Know about Antennas ✨

$$\nabla \cdot \mathbf{D} = \rho$$

$$\nabla \cdot \mathbf{B} = 0$$

$$\nabla \times \mathbf{E} = -\frac{\partial \mathbf{B}}{\partial t}$$

$$\nabla \times \mathbf{H} = \mathbf{J} + \frac{\partial \mathbf{D}}{\partial t}$$



James Clerk Maxwell

Maxwell's Equations in SI convention
(as refined by Oliver Heaviside)



Copyright 2023 Santa Clara County ARES®/RACES. All rights reserved.

27

27

Common Antenna Terms



Antenna Gain

Gain – ratio of power received (or transmitted) in a specific direction (azimuth and elevation) relative to a reference source generally expressed in dB.

- Gain is quoted for the point of maximum gain
- May be for antenna in free space (typical)
- Or above the ground and includes ground effects

Copyright 2023 Santa Clara County ARES®/RACES. All rights reserved.

28

28

Typical Antenna Gain Specifications

- dBd – dB referenced to a dipole antenna
- dBi – dB referenced to an isotropic antenna
 - Isotropic antenna radiates equally in all directions
 - 0 dBd = 2.15 dBi

Typical gains in free space

$\frac{1}{2}$ wave dipole	0 dBd	2.15 dBi
$\frac{1}{4}$ wave ground plane	0 dBd	2.15 dBi
J-pole (end fed $\frac{1}{2}$ wave)	0 dBd	2.15 dBi

- For antennas likely to be used for ARES/RACES other factors will be important
 - Portability, mounting, weight, supporting structure, etc..

Copyright 2023 Santa Clara County ARES®/RACES. All rights reserved.

29

29

Antenna Basics

- Antennas radiate because of changing current flow
- The ideal size for an antenna is $\frac{1}{2}$ wavelength

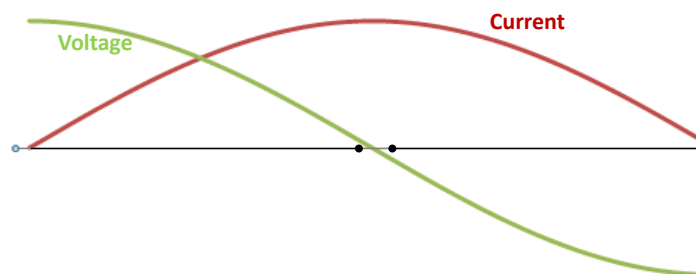

- Zero current at the open ends
- Maximum voltage at the open ends

Copyright 2023 Santa Clara County ARES®/RACES. All rights reserved.

30

30

But what about a $\frac{1}{4}$ wave mag-mount?

- The other $\frac{1}{4}$ wave forms in the metal ground plane

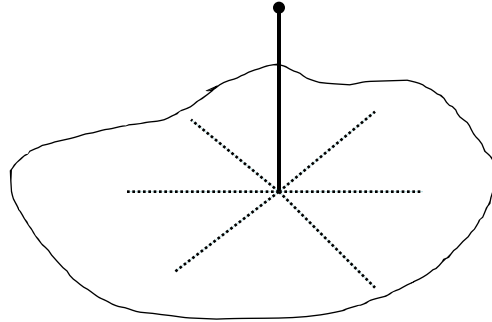

- Same for a vertical HF antenna
 - Wire radials on/in the ground replace the vehicle body

Copyright 2023 Santa Clara County ARES®/RACES. All rights reserved.

31

31

Other Common Antenna Types

- $\frac{1}{4}$ wave ground plane
 - $\frac{1}{4}$ wave vertical with $\frac{1}{4}$ wave tuned radials
 - Radials are sloped so it is not a full half wave tall
 - Easy to mount and connect feed line
 - “Magmount antenna on a cookie sheet”
- J-Pole
 - $\frac{1}{2}$ wave antenna with a transmission line matching section
 - Does not require a ground plane
- $\frac{5}{8}$ wave Vertical
 - $\frac{1}{2}$ wave antenna with an $\frac{1}{8}$ wave matching section
 - Does not require a ground plane

Copyright 2023 Santa Clara County ARES®/RACES. All rights reserved.

32

32



Antenna Pattern

Pattern – a collection of gain measurements for a range of angles in azimuth and elevation at a specific frequency

May be a table or graphical view

Copyright 2023 Santa Clara County ARES®/RACES. All rights reserved.

33

33

½ Wave Vertical Dipole in Free Space

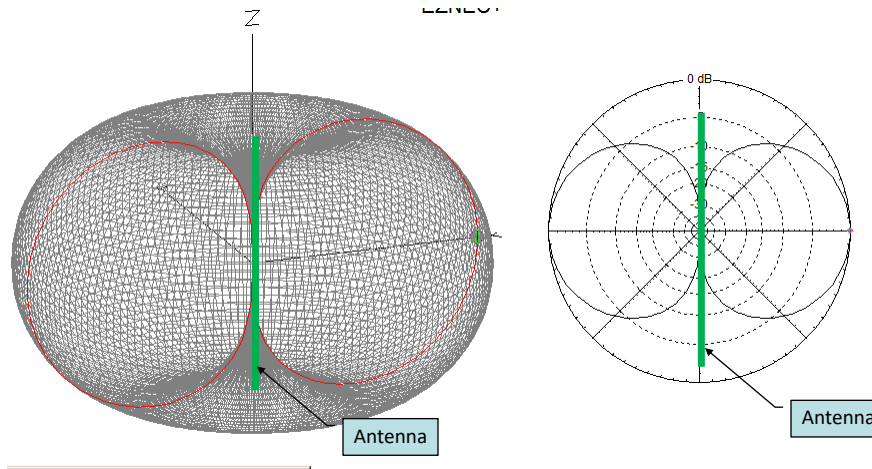

3 D view

Elevation Pattern

Copyright 2023 Santa Clara County ARES®/RACES. All rights reserved.

34

34

½ Wave Vertical Dipole 10 ft. high

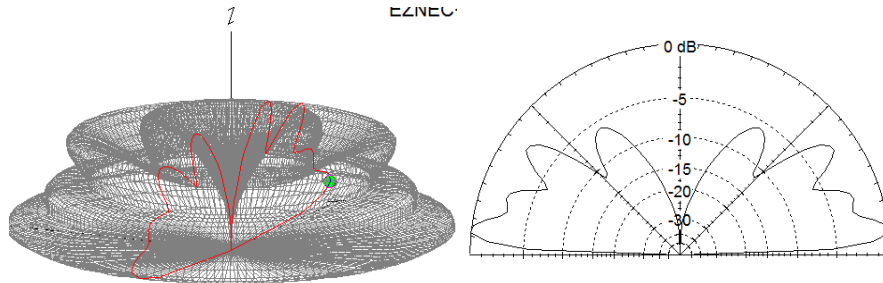

3D View

Elevation Pattern

- The ground cuts off the bottom of the “donut”
- Reflections (multipath) from the ground put notches in the top of the pattern
- Note the null directly above the antenna

Copyright 2023 Santa Clara County ARES®/RACES. All rights reserved.

35

35

J-Pole Antenna Patterns

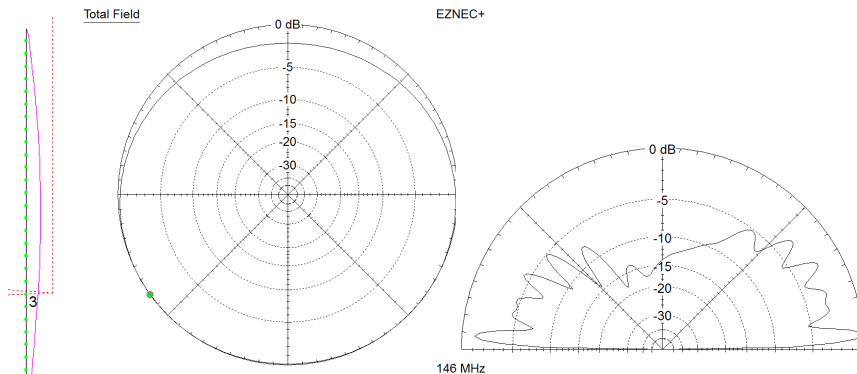

Azimuth

Elevation

- Arrow 144/440 J-pole at 18 ft off the ground (red lines show currents in the antenna)

Copyright 2023 Santa Clara County ARES®/RACES. All rights reserved.

36

36

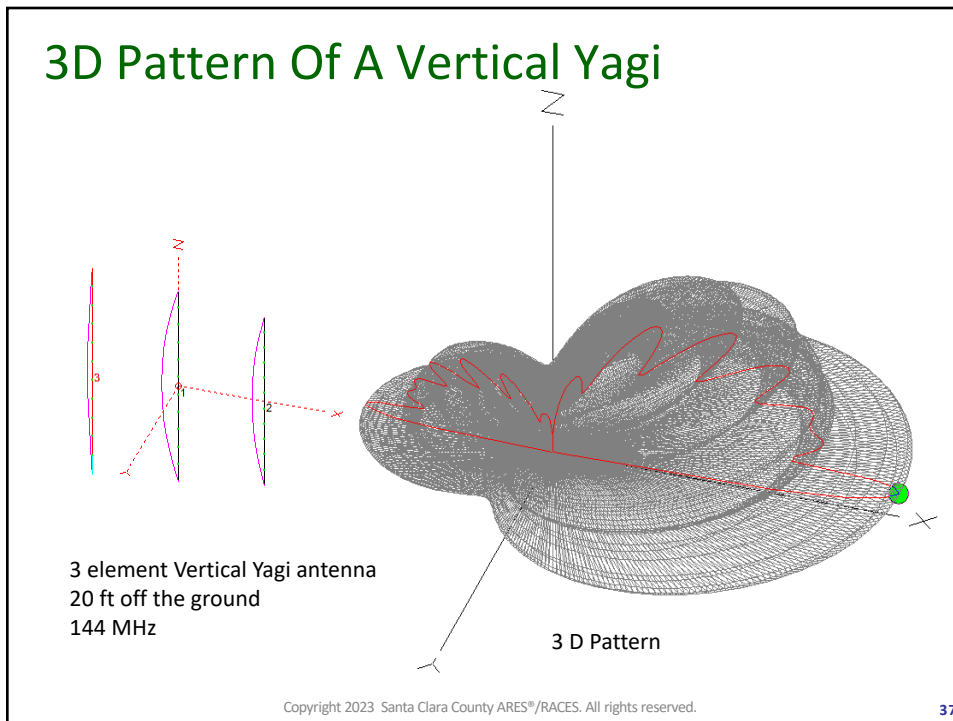

37

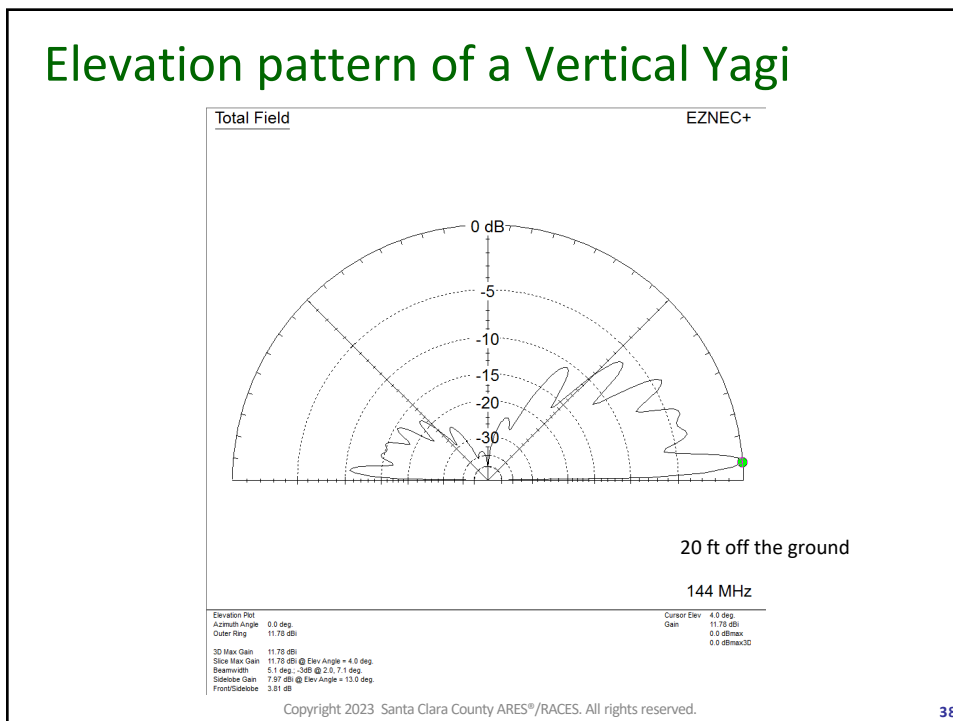

38

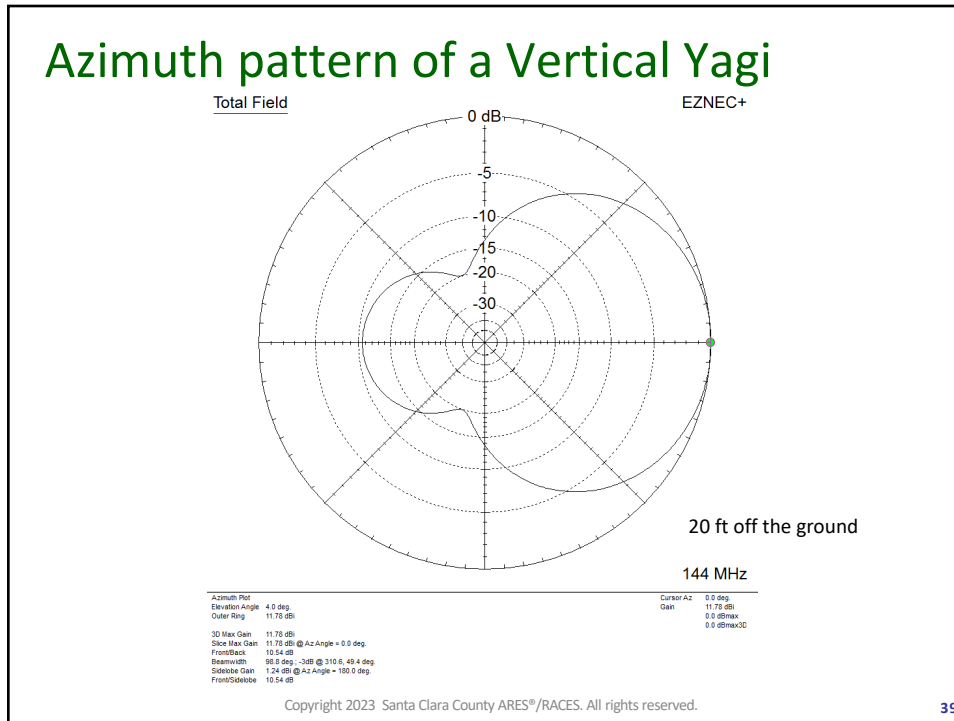

39

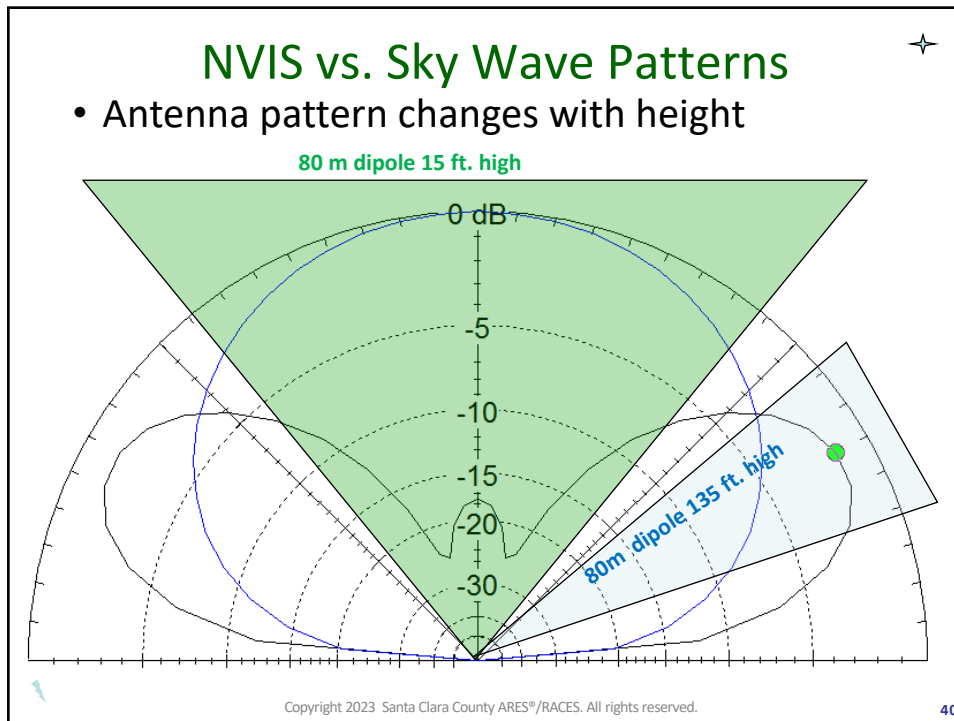

40

Antenna Placement and Safety

For You and Those Around You

Copyright 2023 Santa Clara County ARES®/RACES. All rights reserved.

41

41



Overhead power lines KILL!

The problem is not when the mast is vertical.

It's when it tries to be horizontal!



Copyright 2023 Santa Clara County ARES®/RACES. All rights reserved.

42

42

Antenna Placement Safety



- Perform a site survey and assess
 - Overhead wires and other hazards
 - Traffic patterns, non-intrusive to others
 - Location relative to operating position
 - **Where will the cables go?**
- Clear RF path to intended users
 - Height
 - Building blockages
- Tradeoffs
 - Minimize trip/fall hazards, block off an area
 - High enough for needed coverage, low enough to be safe
 - Wind
 - Stability of supporting structures, tripods, etc..

Copyright 2023 Santa Clara County ARES®/RACES. All rights reserved.

43

43

Placement of Multiple Antennas

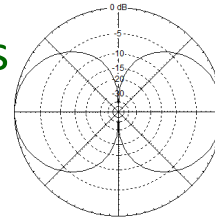

- Typical vertical antenna pattern
 - Most energy is directed horizontally
 - Very little energy is directed vertically
- Vertical separation is best for confined areas
 - i.e. collinear, 10-20 ft. vertical separation; with no horizontal offset
 - Combine vertical and horizontal separation when necessary
- Example (vertical $\frac{1}{2}$ wave dipole):
 - 10 ft. vertical separation \approx 50 ft. horizontal (36 dB)
 - 20 ft. vertical separation \approx 225 ft. horizontal (48 dB)
 - Based on measured data in late 1950s
 - Source:
 - <http://www.repeater-builder.com/antenna/separation.html>

Copyright 2023 Santa Clara County ARES®/RACES. All rights reserved.

44

44

Vertical Antenna Separation Effects

- Data from
 - EZNEC simulation of two vertical dipole antennas separated vertically vs. horizontally
 - ARRL Antenna Handbook, 22nd Edition

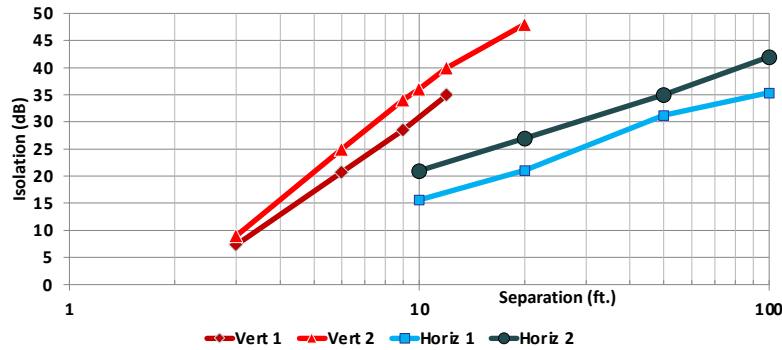

Copyright 2023 Santa Clara County ARES®/RACES. All rights reserved.

45

45

RF Safety Evaluation Report and Order

- Your license requires evaluation, FCC changed the rules and existing stations had until May 03, 2023 to comply.
- New stations need to always evaluate, note that this might apply to you setting up an emergency operation station
- <https://docs.fcc.gov/public/attachments/FCC-19-126A1.pdf>
- It's complicated: the RF exposure limits have not been changed, but more licensees might be required to perform a station evaluation. If you do, keep your work sheets.
- Article in ARRL QST September 2021, pp. 60-62
- <https://www.arrl.org/rf-exposure> , also has a calculator
- Free book download "RF Exposure and You" *

Copyright 2023 Santa Clara County ARES®/RACES. All rights reserved.

46

46

RF Safety Evaluation notes

- Bulletin OET65 has not been updated, 3+ years later
- What is this about? Heating up tissue in your body, and it depends a bit if the tissue is your brain/eyeball or the part you are sitting on. Sawtooth heat up (transmit 1 min), cool down decay curve (receive 2 min), repeat after this cycle. Eventually you will cross the threshold line and stay above.
- The second example leaves enough time to cool down by having longer Rx cycles.
- Important parameters: frequency, duty-cycle, radiated power (energy absorbed into body)

Copyright 2023 Santa Clara County ARES®/RACES. All rights reserved.

47

47

RF Safety Evaluation examples

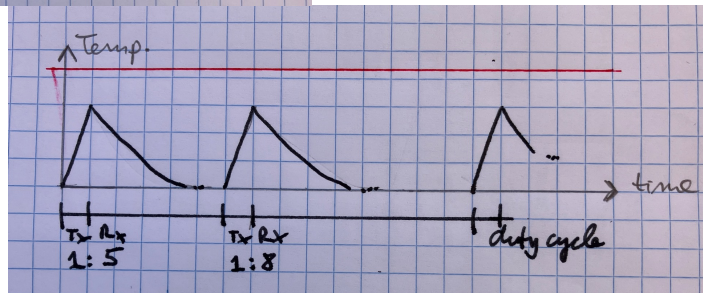
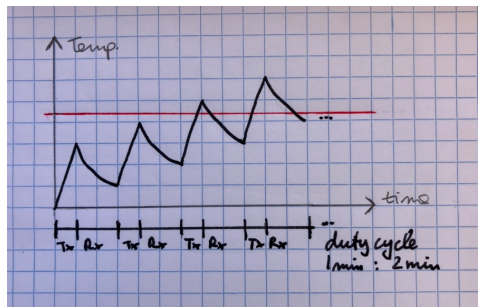

Copyright 2023 Santa Clara County ARES®/RACES. All rights reserved.

48

48

RF Safety Evaluation notes cont.

- Controlled/uncontrolled environment: you (or hams) and your household, unsuspecting public bystander
- Example scenarios from ARRL rf-exposure-calculator (146 MHz, FM, duty cycle is 5 min Tx / 10 min Rx), minimum safe distances shown:
 1. HT in vest pocket: 1 W, gain "0 dB"
 - controlled: 5 ¼ in. uncontrolled: 7 ¼ in.
 2. mobile radio, antenna on push-up mast:
 - 25W, 25 ft coax, total gain 3 dB
 - controlled: 3 ft. uncontrolled: 4 ft. 3 in.
 3. car magmount (metal roof): 50W, total gain 2dB
 - controlled: 3ft. 9 in. uncontrolled: 5 ft. 5 in.

Copyright 2023 Santa Clara County ARES®/RACES. All rights reserved.

49

49



Coax Cable

Connecting the radio to the antenna

Copyright 2023 Santa Clara County ARES®/RACES. All rights reserved.

50

50

Anatomy of Coax Cable

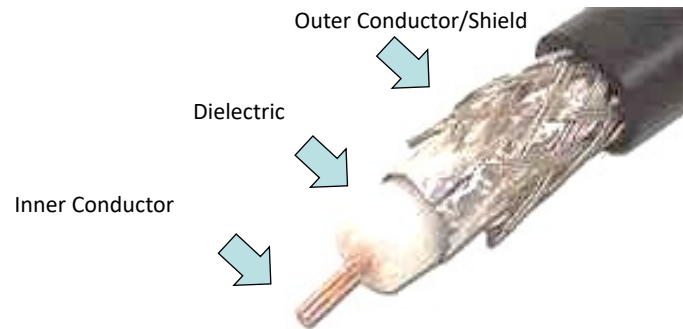

- Impedance depends on ratio of diameters of Inner and Outer conductors and type of dielectric
- Power handling and loss depends of insulating qualities of the dielectric

Copyright 2023 Santa Clara County ARES®/RACES. All rights reserved.

51

51

Coax Cable Considerations

- Shielding – single or double?
 - Single: Single Braid
 - 90% – 96% coverage,
 - Signal leakage
 - Potential source of de-sensing interference with multiple antennas and cables running in bundles
 - Double: Foil Shield plus Outer Braid
 - Almost 100% coverage
 - Dis-similar metals – aluminum and copper, must stay dry
 - Potential source of interference in the presence of strong fields
 - Not used for full duplex (repeaters) stations
 - Fine for personal use
- Other factors – bulk, loss, length may drive selection

Copyright 2023 Santa Clara County ARES®/RACES. All rights reserved.

52

52

Common Types of Coax Cable

- Table of common cable types and approx. losses

<https://www.scc-ares-races.org/operations/coax-feedline-considerations.html>

Cable Type	Approx. Diameter	Shield Type	Attenuation (db/100 ft)					
			10 MHz	30 MHz	50 MHz	150 MHz	220 MHz	450 MHz
LMR-240-UF	0.240"	foil + braid	-	1.6	2.1	3.6	4.4	6.3
LMR-240	0.240"	foil + braid	0.8	1.3	1.7	3.0	3.7	5.3
LMR-400-UF	0.405"	foil + braid	-	0.8	1.1	1.8	2.2	3.3
Belden 9913	0.405"	foil + braid	0.5	0.8	1.0	1.6	1.9	2.8
LMR-400	0.405"	foil + braid	0.4	0.7	0.9	1.5	1.9	2.7
LMR-600	0.6"	foil + braid	0.2	0.4	0.5	1.0	1.2	1.7
RG-8X	0.240"	braid	1.0	2.0	2.3	4.7	-	8.6
RG-8/U	0.405"	braid	0.5	0.8	1.1	1.8	2.2	3.3
RG-213/U	0.405"	braid	0.6	1.2	1.5	2.8	-	5.2
RG-214/U	0.425"	braid x 2	0.6	0.9	1.3	2.3	-	4.5
1/2" Helix Superflex (FSJ4-50B)	0.5"	solid	0.3	0.6	0.7	1.3	1.5	2.3
1/2" Helix (LDF4-50)	0.5"	solid	0.2	0.4	0.5	0.8	0.9	1.4
7/8" Helix (AVA5-50)	0.875"	solid	0.1	0.2	0.2	0.4	0.5	0.8

"-" means no data available from the manufacturer. Interpolate to get a rough idea.

Copyright 2023 Santa Clara County ARES®/RACES. All rights reserved.

53

53

Cable Considerations

- Things to consider when selecting a cable
 - Length & associated loss at frequency
 - Permanence of installation
 - Handling and misuse
 - Cost

25 ft. Run

- **144, 5 watts**
 - 9913F7 (fat) 4.6w at ant
 - RG8X (skinny) 4.2w at ant
- **440, 5 watts**
 - 9913F7 4.2w at ant
 - RG8X 3.4w at ant

100 ft. Run

- **144, 5 watts**
 - 9913F7 3.5w at ant
 - RG8X 2.4w at ant
- **440, 5 watts**
 - 9913F7 2.5w at ant
 - RG8X 1.1w at ant

Copyright 2023 Santa Clara County ARES®/RACES. All rights reserved.

54

54

Coax Connectors

- SMA/Reverse SMA
 - SubMiniature version **A**
 - Developed in the 1960s by Omni-Spectra from Bendix real miniature connector by James Cheal
 - DC to 18 GHz
 - .02dB loss at 440, .095dB at 10 GHz
 - Limited mating cycles – 250
- UHF - PL-259 (plug), SO-239(socket), M (Japanese designation)
 - Invented in 1930s by E. Clark Quackenbush at Amphenol
 - Low cost, rugged connector for field use in WWII
 - 0-30 MHz design, usable to 300 MHz
 - Not constant impedance, ~.1 db loss, per connection at VHF
 - “\$3.00”

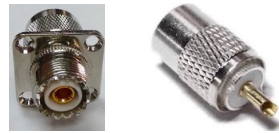

Copyright 2023 Santa Clara County ARES®/RACES. All rights reserved.

55

55

More Coax Connectors

- Type N Connector
 - Invented in the 1940's by Paul Neill of Bell Labs
 - Constant impedance
 - Variations
 - N – full size
 - BNC – Bayonet N Connector
 - TNC – Threaded N Connector
 - Very low loss .15dB at 10 GHz! –
 - Virtually zero at VHF/UHF
 - More expensive than UHF connectors
 - Weatherproof (mostly)
- Cable assemblies with N connectors are about \$10 more expensive

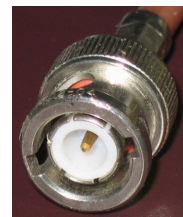

Copyright 2023 Santa Clara County ARES®/RACES. All rights reserved.

56

56

Getting Power Through The Cable

Some power goes to the antenna,
Some power comes back

Copyright 2023 Santa Clara County ARES®/RACES. All rights reserved.

57

57

What is SWR?

- Standing Wave Ratio (SWR)
 - Derived measure of the amount of power that goes into the antenna compared to the power reflected back to the radio

$$\text{SWR} = \frac{1 + |\rho|}{1 - |\rho|}$$

$|\rho|$ = magnitude of voltage reflection coefficient
 - Or: Ratio of Source and Load impedances

1.0	No reflected power, perfect match
1.5	4% reflected power
2.0	11% reflected power

For VHF/UHF, you should keep SWR below 2.0
- Most commercial VHF/UHF antennas will be below 2.0 SWR “out of the box”
- Can be checked with an SWR meter or Antenna Analyzer

Copyright 2023 Santa Clara County ARES®/RACES. All rights reserved.

58

58

Return Loss

- Power returned to the source expressed as a loss relative to the input power
- Example
 - 100 watts input, 10 watts reflected = 10dB RL
- Why use return loss
 - Can be used directly for system calculations
 - Logarithmic scale which facilitates measurement over a wide dynamic range

SWR	RL
1.5	14 dB
2.0	9.5
3.0	6.0
∞	0

Copyright 2023 Santa Clara County ARES®/RACES. All rights reserved.

59

59

Examples of SWR Meters – Cross Needle

- Cross needle type
 - Two needles – forward and reflected power
 - Read SWR where the two cross

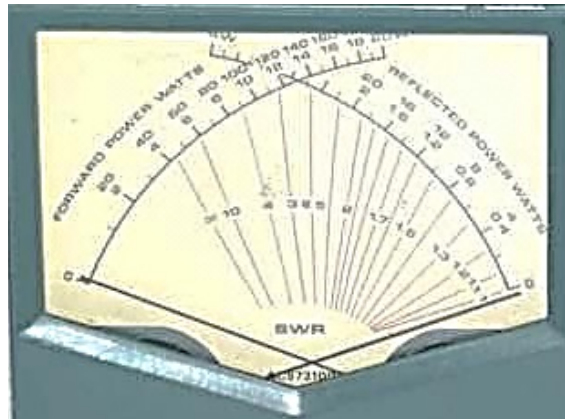

Copyright 2023 Santa Clara County ARES®/RACES. All rights reserved.

60

60

Examples of SWR Meters – Direct Read

- Select Forward Power, adjust so needle is at the SET point
- Switch to read Reflected Power and read SWR

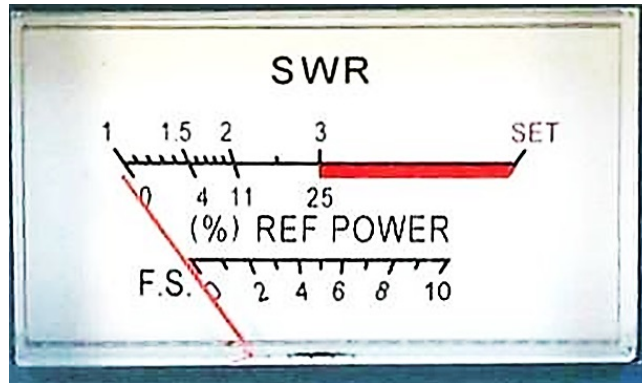

Copyright 2023 Santa Clara County ARES®/RACES. All rights reserved.

61

61

Antenna Analyzers

- “Classic”
 - Measures antenna characteristics at a specific frequency
 - SWR
 - Impedance – R and X (capacitance or inductance)
 - Too long – inductive, Too short - capacitive
 - Does not measure phase
- Vector Network Analyzer
 - Sweep frequency range, Graphical display
 - One port – reflective measurement
 - Two port – reflective and transmission (through) measurement

Copyright 2023 Santa Clara County ARES®/RACES. All rights reserved.

62

62

Antenna Analyzer Characteristics

- Measurements
 - SWR, Return Loss (RL)
 - Resistance, Inductance/Capacitance, Impedance
 - Phase
- Most commercial VHF/UHF antennas can be used without an analyzer
- If you are building/cutting antennas, an Antenna Analyzer is helpful
- New Opensource hardware and software NanoVNA tools

Copyright 2023 Santa Clara County ARES®/RACES. All rights reserved.

63

63

Examples of Antenna Analyzers



Classic: MFJ 259/269

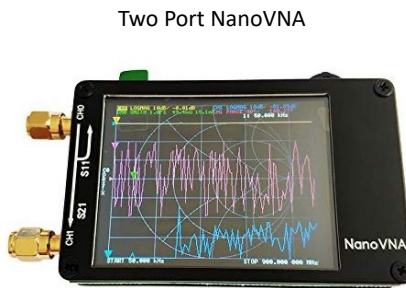

Two Port NanoVNA



VNA One Port:
Rig Expert AA-600



VNA Two Port: MFJ 225

Copyright 2023 Santa Clara County ARES®/RACES. All rights reserved.

64

64

Example: Return Loss Measurement

- MFJ 225 Graphical Antenna Analyzer/IG miniVNA
- 50 ohm dummy load

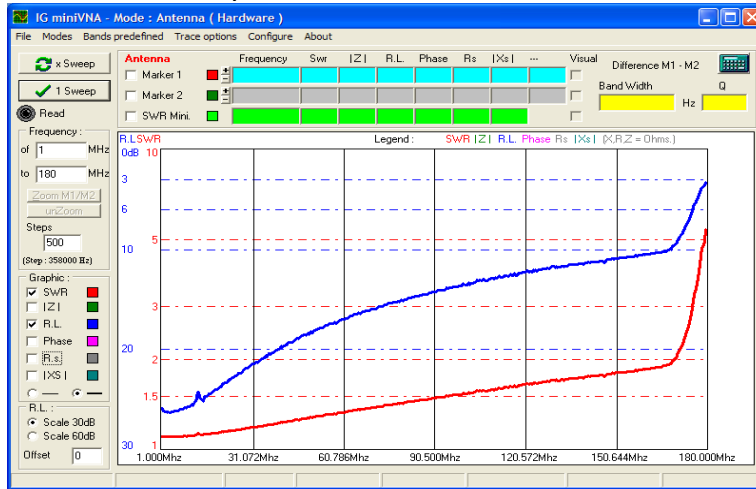

65

65

Example: NanoVNA-Saver

Sweep: Smith Chart, Return Loss, Polar Plot, Impedance/Reactance

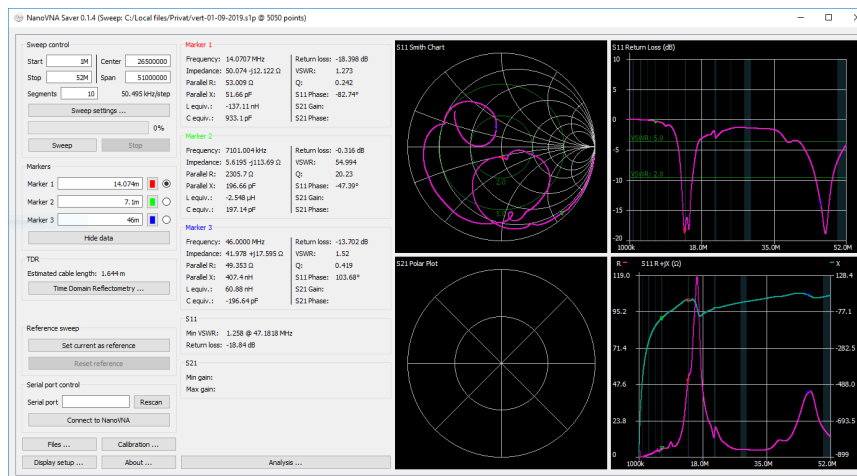

66

66

The Radio

Finding the right signal

Copyright 2023 Santa Clara County ARES®/RACES. All rights reserved.

67

67

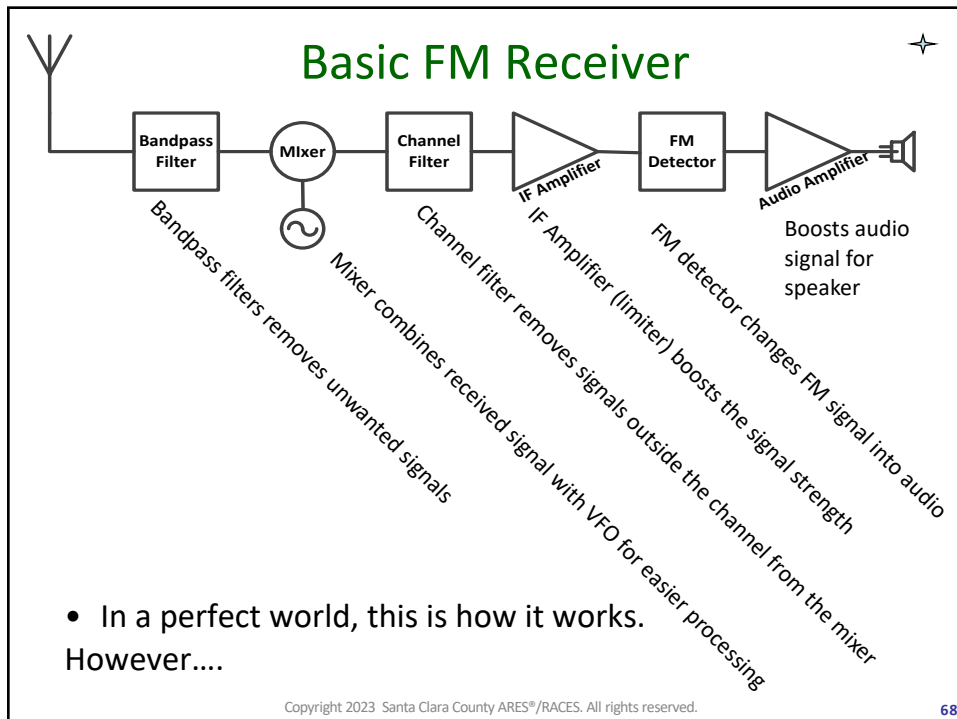

68

The Imperfect World Causes Problems

- **Fundamental Overload**
 - Signal from nearby frequency causes interference with desired signal
- **Intermodulation**
 - Multiple signals combine in the Mixer to produce interference

Copyright 2023 Santa Clara County ARES®/RACES. All rights reserved. 69

69

Fundamental Overload – What Is It?

- Overload of a radio receiver due to the strength of an undesired signal's fundamental carrier or modulation component
- Ham radios with wide filters are more susceptible than commercial radios, too much RF entering the radio where it shouldn't
- Trend of making software driven radios and leave out the RF engineering hardware
- Most cases of interference are due to fundamental overload

Copyright 2023 Santa Clara County ARES®/RACES. All rights reserved. 70

70

Fundamental Overload Remedies

- Reduce the strength of the interfering signal
 - Antenna spacing
 - Re-orient antennas if directional
 - Reduce power
 - Ferrite beads to reduce induced currents
 - Antenna feed point
 - Cables attached to the radio
- Frequency Separation – space them farther apart
- Band Separation – use another band for one signal
- Filters as a last resort (e.g. repeater uses cavities)

Copyright 2023 Santa Clara County ARES®/RACES. All rights reserved.

71

71

Intermodulation Distortion

- Commonly called “Intermod” or IMD
- Two or more signals mix to create products that cause interference on the frequency of interest due to non-linearity of system components
- IMD can be created by
 - Internal circuits in the receiver that are non-linear
 - Non-linear junctions (called Passive Intermod or PIM)
 - Loose connections, corrosion in metal to metal contacts or inside your antenna cable, dissimilar metals, etc.
 - May be a combination of fundamental and harmonic frequencies
- The IMD signal doesn’t need to land exactly on another frequency in use. If it is strong enough and close enough, then it creates fundamental overload for receivers on that frequency – just created by a different cause.

Copyright 2023 Santa Clara County ARES®/RACES. All rights reserved.

72

72

Lots of Combinations Are Possible ✦

- The 2021 countywide drill had ~ 25 frequencies to coordinate, transmitting on any two frequencies simultaneously will produce intermodulation distortion on a third frequency
- For N number of frequencies, f , Intermodulation products will exist at the frequencies

$$k_1 f_1 + k_2 f_2 + \dots + k_N f_N$$

where k_1, k_2, \dots, k_N are arbitrary positive or negative integers

- Intermodulation Order = $|k_1| + |k_2| + \dots + |k_N|$
(Sum of the absolute values of the k factors)
- Example of determining the order

$$2f_1 - (1)f_2 \rightarrow 2 + 1 = 3 \rightarrow 3^{\text{rd}} \text{ order}$$

$$(1)f_1 - (1)f_2 + (1)f_3 \rightarrow 1 + 1 + 1 = 3 \rightarrow 3^{\text{rd}} \text{ order}$$

- Example of calculating an intermod frequency $2f_1 - f_2$
 $f_1 = 146.640 \quad f_2 = 147.370$
 $2 * 146.640 - 147.370 = 145.910$

Copyright 2023 Santa Clara County ARES®/RACES. All rights reserved.

73

73

IMD Concerns For Amateur Field Sites

- Primarily concerned with odd orders (non-linear effects)
 - Few other transmitters nearby
- Most important odd order is the 3rd order since it's magnitude will be the next largest
 - For each combination of f_1 and f_2 (omitting math here)
 - $2f_1 - f_2, 2f_2 - f_1$ are of concern in the same band
 - If a third signal is present
 - $f_1 + f_2 - f_3, f_1 - f_2 + f_3, f_2 + f_3 - f_1, 2f_1 - f_2 \text{ or } 3, 2f_2 - f_1 \text{ or } 3, 2f_3 - f_1 \text{ or } 3$ are of concern
 - Other combinations mostly out of band
- The 5th order and higher usually have an amplitude that is too low to matter.

Copyright 2023 Santa Clara County ARES®/RACES. All rights reserved.

74

74

Shared Sites Like EOCs

- Need to worry about both odd and even orders, since what's out of band for us may be in band for fire, law enforcement, EMS, cellular, satellite, etc.
 - Odd orders like a field site
 - For each combination of f_1 and f_2
 $2f_1-f_2$, $2f_2-f_1$ are of concern
 - If a third signal is present
 $f_1+f_2-f_3$, $f_1-f_2+f_3$, $f_2+f_3-f_1$
 $(2f_1 - f_2)$, $(2f_1 - f_3)$, $(2f_2 - f_1)$, $(2f_2 - f_3)$,
 $(2f_3 - f_1)$, $(2f_3 - f_2)$
 are of concern
 - Even orders, too, because lots of services are involved
 - You may interfere with non-amateur radio services
 $f_1 + f_2$, $2f_1 + 2f_2$, f_1-f_2 , $2f_1 - 2f_2$

Copyright 2023 Santa Clara County ARES®/RACES. All rights reserved.

75

75

Remedies

- Frequency Choice
 - Use widely spaced frequencies, different bands
 - Use a software tool to calculate IMD products and make sure they don't fall on (or adjacent to) another frequency in use
 - Simple spreadsheet tool is available on county web site
- Antenna spacing – horizontal and vertical
 - IMD may form but be too weak to cause problems
- Power
 - Reducing power of the fundamental frequency also reduces the power of the intermodulation products

Copyright 2023 Santa Clara County ARES®/RACES. All rights reserved.

76

76

Intermodulation Products: 2 Transmitters

- To simplify, ignore the $\sin()$ and $\cos()$ terms and focus on the frequency terms
- Calculating for two frequencies is simple (albeit tedious)
- For two transmitters, the four 3rd order products are:
 - $(2f_1-f_2)$, $(2f_2-f_1)$, $(2f_1+f_2)$, $(2f_2+f_1)$
 - The first two are of most interest because they are near the two transmitters (and may land close to other nearby transmitters)
 - The last two are typically out of band
 - Won't affect our other transmitters in same band
 - Could affect other radio services at a shared transmitter site if not filtered, but not so important for an isolated ham radio event

Copyright 2023 Santa Clara County ARES®/RACES. All rights reserved.

77

77

Intermodulation Products – 3 Transmitter

- For 3rd order: $|k_1| + |k_2| + |k_3| = 3$
- For three transmitters, the nine 3rd order products are:
 - $(f_1 + f_2 - f_3)$, $(f_1 + f_3 - f_2)$, $(f_2 + f_3 - f_1)$
 - $(2f_1 - f_2)$, $(2f_1 - f_3)$, $(2f_2 - f_1)$, $(2f_2 - f_3)$, $(2f_3 - f_1)$, $(2f_3 - f_2)$
- Fun right?
- Now, imagine trying to calculate for the most common IMD issues:
 - 2-TX 3rd Order, 3-TX 3rd Order, 2-TX 5th Order
 - Check out intermod calculators
 - Search for online calculators and/or downloadable software
- Recommendation:
 - Whenever possible, calculate the 2-TX 3rd order products and avoid those frequencies: $(2f_1 - f_2)$, $(2f_2 - f_1)$
 - Use an IMD calculator to select the best frequencies to use at an event

Copyright 2023 Santa Clara County ARES®/RACES. All rights reserved.

78

78

Demonstration

- Group A – Receive on 144.500
- Group B – Transmit on 146.500
- Group C – Transmit on 145.500

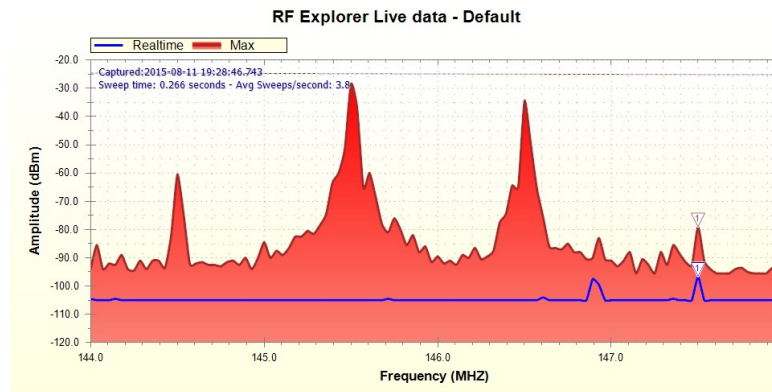

79

79

Intermod Calculator Spreadsheet

- Follow instructions on sheet where to enter your two simplex, one simplex plus a repeater output/offset, and a third receive frequency
- Calculation for two transmit frequencies is performed for you, results are checked against three receive frequencies
- For two transmitters, the four most interesting 3rd order products are displayed and cells use conditional formatting to display red background if too close to the third frequency
 - $(2f_1 - f_2)$, $(2f_2 - f_1)$, $(2f_1 + f_2)$, $(2f_2 + f_1)$
 - The first two are of most interest because they are near the two transmitters (or may land close to other nearby receivers)
 - The last two are typically out of band (beware of UHF is 3 x VHF)
 - Won't affect our other receivers
 - Could affect other radio services at a shared transmitter site if not filtered, but not so important for an isolated ham radio event
- Bonus: Spreadsheet also calculates 3rd harmonics

Copyright 2023 Santa Clara County ARES®/RACES. All rights reserved.

80

80

Intermod Calculator Spreadsheet 2

Intermod calculator

File Edit View Insert Format Data Tools Add-ons Help All changes saved in Drive

100% \$ % 0 .00 123 Default (Ar...) 10 B I U A

Instructions: Put three simplex or output frequencies into bold cells E4, G4 and I4 (f1, f2, f3 [MHz]), then add repeater offset +/- [MHz] or zero for simplex, input will be calculated

	f1 output	f1 input	f2 output	f2 input	f3 output	f3 input
Frequencies	145.170	144.570	147.500	147.500	442.500	447.500
repeater offset	-0.600		0.000		5.000	

Products category	3rd order	Intermod	ABS(intermod)						
interesting	f1+f2-f3	-149.830	149.830	4.660	5.260	2.330	2.330	-292.670	-297.670
interesting	-f1+f2+f3	444.830	444.830	299.660	300.260	297.330	297.330	2.330	-2.670
interesting	f1-f2+f3	440.170	440.170	295.000	295.600	292.670	292.670	-2.330	-7.330
very interesting	2f1-f2	142.840	142.840	-2.330	-1.730	-4.660	-4.660	-299.660	-304.660
very interesting	2f1-f3	-152.160	152.160	6.990	7.590	4.660	4.660	-290.340	-295.340
very interesting	2f2-f1	149.830	149.830	4.660	5.260	2.330	2.330	-292.670	-297.670
very interesting	2f2-f3	-147.500	147.500	2.330	2.930	0.000	0.000	-295.000	-300.000
interesting	2f3-f1	739.830	739.830	594.660	595.260	592.330	592.330	297.330	292.330
interesting	2f3-f2	737.500	737.500	592.330	592.930	590.000	590.000	295.000	290.000
3rd harmonics	3f1	435.51	435.510	290.340	290.940	288.010	288.010	-6.990	-11.990
3rd harmonics	3f2	442.5	442.500	297.330	297.930	295.000	295.000	0.000	-5.000
3rd harmonics	3f3	1327.5	1327.500	1182.330	1182.930	1180.000	1180.000	885.000	880.000
outliers	2f1+f2	437.840	437.840	292.670	293.270	290.340	290.340	-4.660	-9.660
outliers	2f1+f3	732.840	732.840	587.670	588.270	585.340	585.340	290.340	285.340
outliers	2f2+f1	440.170	440.170	295.000	295.600	292.670	292.670	-2.330	-7.330
outliers	2f2+f3	737.500	737.500	592.330	592.930	590.000	590.000	295.000	290.000
outliers	2f3+f1	1030.170	1030.170	885.000	885.600	882.670	882.670	587.670	582.670
outliers	2f3+f2	737.500	737.500	592.330	592.930	590.000	590.000	295.000	290.000

red=closer than 0.015 MHz
green=further than 0.025 MHz

Copyright 2023 Santa Clara County ARES®/RACES. All rights reserved. 81

81

Sidebar: Two Ways to Visualize a Signal

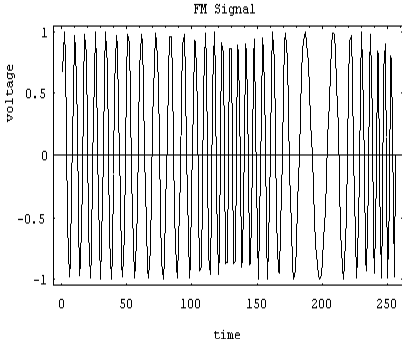

FM Signal

Variation over time
Easy to use with audio

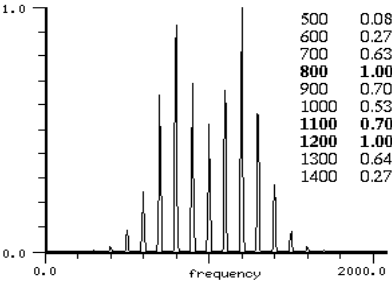

Variation in Frequency
Useful for talking about RF

Copyright 2023 Santa Clara County ARES®/RACES. All rights reserved. 82

82

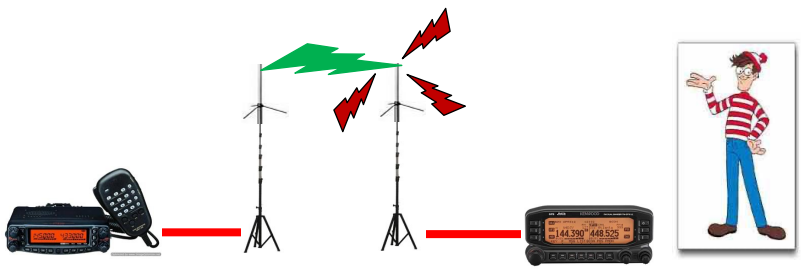

Conclusion

Copyright 2023 Santa Clara County ARES®/RACES. All rights reserved. 83

83

Bringing it all together (1)

- Radio
 - As needed to meet the communication needs
 - See Field Communicator, Net Control, and Packet classes
- Connector style
 - Few connections, little activity above 144, UHF will suffice
 - Otherwise, consider N connectors
 - Adaptors will introduce more loss
- Coax Cables
 - Less than 50 ft., little activity above 144, RG8X is fine
 - Very flexible, small bulk, easy to get through doorways
 - Longer runs, more 440 work, consider LMR 400 Ultraflex, CXP1318, or Belden 9913F7
 - Low Loss for 440
 - Bulkier, heavier, less flexible

Copyright 2023 Santa Clara County ARES®/RACES. All rights reserved.

84

84

Bringing it all together (2)

- Antenna
 - ½ wave preferred – Roll up J-pole
 - Highly portable, low supported weight on a mast
 - Dual band 144/440 (check your VSWR on packet frequencies)
- Tripod/Mast
 - 18 ft.
 - May not clear obstacles
 - Integrated with tripod
 - Easy to set up
 - Smaller footprint
 - 30ft
 - Will clear most obstacles, extends radio horizon
 - Requires heavier tripod, stabilizing weights
 - May limit antenna selections due to supported weight
 - Larger “safety” zone
 - Height is more important than total antenna gain

Copyright 2023 Santa Clara County ARES®/RACES. All rights reserved.

85

85

Thank You!

If you have questions or feedback about this or other training activities, you can join our Training discussion group.

<https://scc-ares-races.groups.io/g/training>

This is a moderated group.

Copyright 2023 Santa Clara County ARES®/RACES. All rights reserved.

86

86

Thank You!



Don't forget to fill out your evaluation forms
Questions, comments, suggestions?
Andreas Ott – andreas@naund.org
Credits: Logan Zintsmaster KE7AZ (ex KZ6O)

Copyright 2023 Santa Clara County ARES®/RACES. All rights reserved.

87

87

Reference

Copyright 2023 Santa Clara County ARES®/RACES. All rights reserved.

88

88

Reference Links 1

- Bandplan chart ARRL
 - <http://www.arrl.org/graphical-frequency-allocations>
- ARRL RF exposure page and calculator
 - <https://www.arrl.org/rf-exposure>
 - <https://www.arrl.org/rf-exposure-calculator>
- FCC RF Safety Evaluation Report and Order
 - <https://docs.fcc.gov/public/attachments/FCC-19-126A1.pdf>
- Fresnel Zone (example 900MHz data link)
 - <https://www.youtube.com/watch?v=HWOivbJiw7s>
- Intermodulation calculator
 - Beta version on county web site, Python script development
- Intermodulation article
 - <https://en.wikipedia.org/wiki/Intermodulation>

Copyright 2023 Santa Clara County ARES®/RACES. All rights reserved.

89

89

Reference Links 2

- Velocity factor of cables
 - https://www.febo.com/reference/cable_data.html
- NanoVNA
 - <https://nanovna.com/>
 - <https://groups.io/g/nanovna-users/>
- Maxwell Equations (Prof. Carlson, Purdue)
 - <https://www.youtube.com/watch?v=fkfnDopQBYQ&t=908s>
 - https://www.youtube.com/watch?v=v57B_1ZBAho&list=PLZ6kagz8q0bvxaUKCe2RRvU_h7wtNNxxi (playlist Physics 272 lectures: Electric and Magnetic interactions)
- Basics of the Smith Chart (W2AEW videos)
 - <https://www.youtube.com/watch?v=TsXd6GktIYQ>

Copyright 2023 Santa Clara County ARES®/RACES. All rights reserved.

90

90

Reference Links 3

- Antenna simulation software
 - EZNEC
 - MMANA-GAL
- Radio Line of Sight (over terrain)
 - <https://www.scadacore.com/tools/rf-path/rf-line-of-sight/>
- more

Copyright 2023 Santa Clara County ARES®/RACES. All rights reserved.

91

91

Fresnel Zone example: 5GHz Wi-Fi links

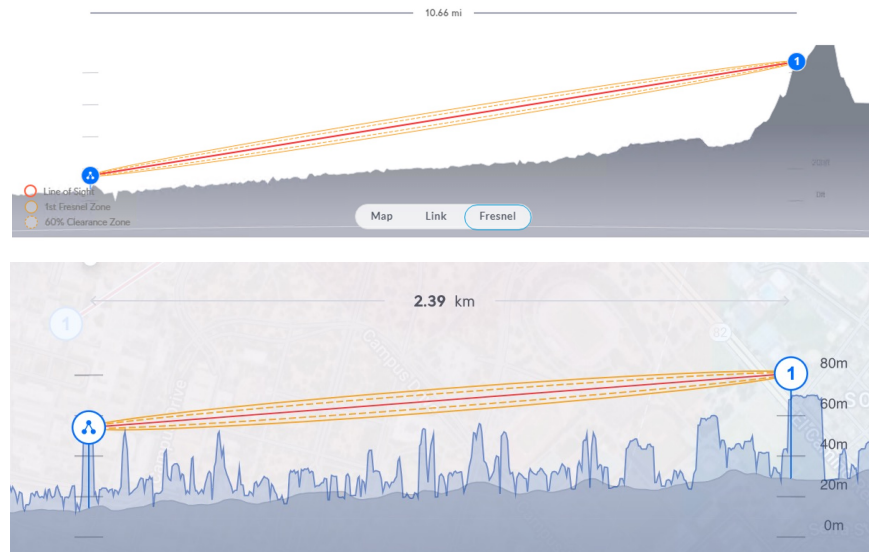

Copyright 2023 Santa Clara County ARES®/RACES. All rights reserved.

92

92

OLD: RF Safety Evaluation

- License requires evaluation
- FCC Bulletin OET 65 Appendix B is written specifically for hams
- Keep human exposure below specified levels (24-450MHz)
- Table shows when evaluation is required
- Power level includes both transmitter power and isotropic gain of antenna
 - Dipole => 2.15dBi

Band	Power	Band	Power
160m	500 W	6m	50 W
80	500	2m	50 W
40	500	1.25m	50 W
30	425	70cm	70 W
20	225	33	150
17	125	23	200
15	100	13	250
12	75		
10m	50 W		

Copyright 2023 Santa Clara County ARES®/RACES. All rights reserved.

93

93

OLD: OET Bulletin 65 Appendix B...

- VHF/UHF - Less than 50 watts radiated, no evaluation needed
- Safe exposure distance from the antenna for 50 watt transmitter and different antennas from Bulletin 65 (worst case), watch for magmount on top of car



	(dBi)	(feet)
144(2m)	3	10.6
	6	14.9
222(1.25m)	3	10.6
	6	14.9
450 (70 cm)	3	8.6
	6	12.2

Copyright 2023 Santa Clara County ARES®/RACES. All rights reserved.

94

94

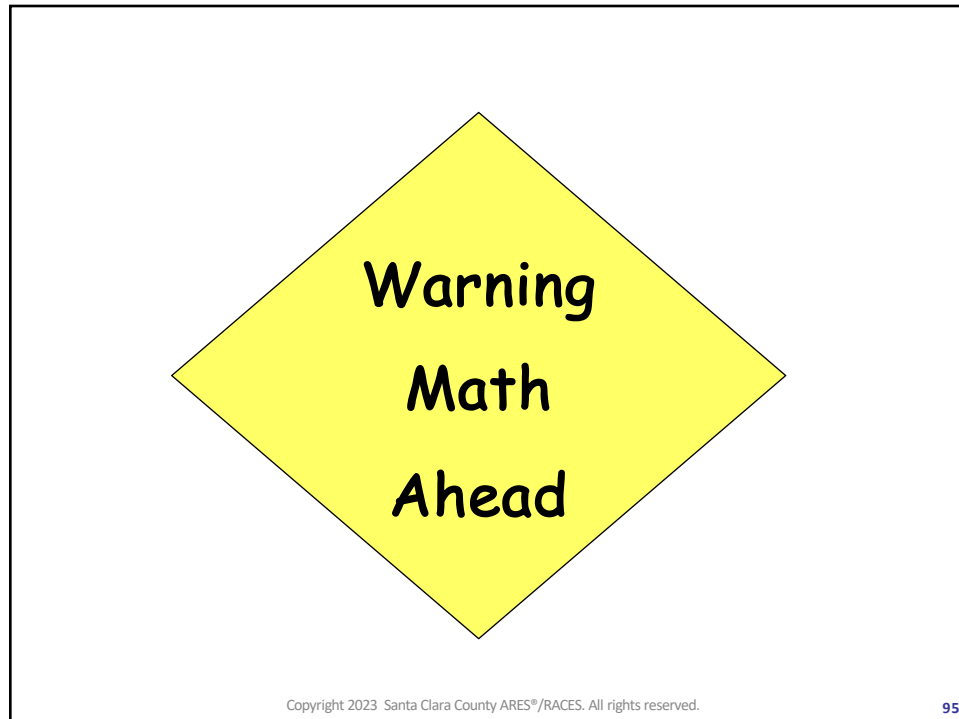

95

IMD Products Form In The Mixer

The diagram shows a signal path starting from an antenna, passing through a Bandpass Filter, then a Mixer (which is also connected to a local oscillator symbol), then a Channel Filter, an IF Amplifier, an FM Detector, and finally an Audio Amplifier connected to a speaker.

- The mixer multiplies two signals together to form a two new signals
- The new signals may also mix with the input signals
- Mathematically, these signals are represented as $\cos(f_n)$
- Caution: Trigonometry follows....

Copyright 2023 Santa Clara County ARES®/RACES. All rights reserved.

96

Mixer Mathematics (we did warn you!)

- Mixer Output with two input signals, f_1 and f_2

$$\cos(f_1) * \cos(f_2) = \frac{1}{2} \cos(f_1 + f_2) + \frac{1}{2} \cos(f_1 - f_2)$$

- Input signal mixing with signals in the mixer

$$\begin{aligned} \cos(f_1) * \frac{1}{2} \cos(f_1 - f_2) &= \frac{1}{2} * \frac{1}{2} * \cos(f_1 + (f_1 - f_2)) \\ &\quad + \frac{1}{2} * \frac{1}{2} * \cos(f_1 - (f_1 - f_2)) \\ &= \frac{1}{4} \cos(2f_1 - f_2) + \frac{1}{4} \cos(f_2) \end{aligned}$$

And so on

Each mixer output gets weaker each time it is mixed

5th order and above are usually too weak to cause problems

Copyright 2023 Santa Clara County ARES®/RACES. All rights reserved.

97

97

Intermodulation Products – 2 Transmitter

- To simplify, ignore the cos() and focus on the frequency terms
- Calculating for two frequencies is simple (albeit tedious)
- For two transmitters, the four 3rd order products are:
 - $(2f_1-f_2), (2f_2-f_1), (2f_1+f_2), (2f_2+f_1)$
 - The first two are of most interest because they are near the two transmitters (and may land close to other nearby transmitters)
 - The last two are typically out of band
 - Won't affect our other transmitters
 - Could affect other radio services at a shared transmitter site if not filtered, but not so important for an isolated ham radio event

Copyright 2023 Santa Clara County ARES®/RACES. All rights reserved.

98

98

Intermodulation Products – 3 Transmitter

- For 3rd order: $|k_1| + |k_2| + |k_3| = 3$
- For three transmitters, the nine 3rd order products are:
 - $(f_1 + f_2 - f_3), (f_1 + f_3 - f_2), (f_2 + f_3 - f_1)$
 - $(2f_1 - f_2), (2f_1 - f_3), (2f_2 - f_1), (2f_2 - f_3), (2f_3 - f_1), (2f_3 - f_2)$
- Fun right?
- Now, imagine trying to calculate for the most common IMD issues:
 - 2-TX 3rd Order, 3-TX 3rd Order, 2-TX 5th Order
 - Check out intermod calculators
 - Search for online calculators and/or downloadable software
- Recommendation:
 - Whenever possible, calculate the 2-TX 3rd order products and avoid those frequencies: $(2f_1 - f_2), (2f_2 - f_1)$
 - Use an IMD calculator to select the best frequencies to use at an event

Copyright 2023 Santa Clara County ARES®/RACES. All rights reserved.

99

99