

USE AND DISTRIBUTION NOTICE

- Santa Clara County RACES authorization is granted to use and duplicate this material as-is as long as this page and the copyright notices on each page are included, acknowledging Santa Clara County ARES/RACES as the holder of the copyright.
- Permission is granted to adapt this presentation to your needs as long as you acknowledge our copyright and include a note similar to "adapted with permission from Santa Clara County ARES/RACES"
- For additional information on training or any of our programs send an email to: info@scc-ares-races.org



Packet Type II



Santa Clara County ARES®/RACES/ACS

Last Updated: 9 October 2023

ARES and Amateur Radio Emergency Service are registered service marks of the American Radio Relay League Incorporated and are used by permission.

© Copyright 2011-2023 Santa Clara County ARES®/RACES. All rights reserved.

2

HOUSEKEEPING

- Introductions
- Pen/pencil & paper
- Cell phones
- Side conversations
- Questions
- Corrected Handouts
- Breaks
- Restrooms (code: 9033)
- In case of emergency
- No wandering or exploring other areas of the building.

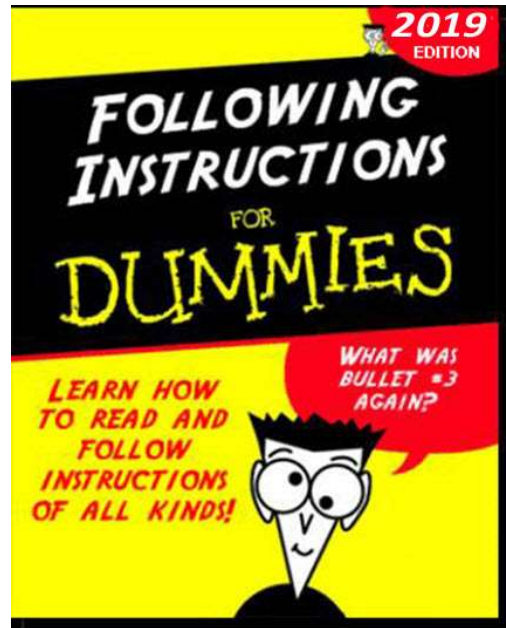

Overview: Packet Classes

Packet Type III, Part A

- Role of the Packet Operator
- Packet Network Overview
- Packet Network Components
- Packet Station HW & SW
- Accessing the Network
- Standard Workflow

Packet Type III, Part B

- Packet Operations
- Diagnosing Setup Problems
- Selecting a BBS
- Creating Messages
- Event Documentation
- Productivity Hints
- Exercises

Packet Type III, Part A+

- Packet Operations Self-Paced
Exercise workbook

Packet Type II: Advanced Techniques, such as County EOC Packet Station Setup & Operations, Operating without Outpost.

Learning Objectives

At the end of this class, you should be able to:

- Understand the setup and operation of the county EOC radio room packet station
- Set up and use a terminal program to access a BBS
- Without Outpost...
 - Connect to a JNOS BBS
 - Send and receive plain text messages with BBS commands
 - Send and receive PackItForms with BBS commands

A Note on receiving Class Credit

To get credit for this class, there are 3 things that you need to do:

1. Attend the classroom session.
2. Complete the evaluation by the Saturday, one week after the class. See the instructions at the end of this material.
3. Complete the exercise by the Saturday, one week after the class.

Fictitious Examples

- We use fictitious call signs in this presentation to avoid SPAM

- W6XRL4: Herman Munster



- XNDEOC: City of Xanadu Emergency Operations Center



What about Xanadu?



- Xanadu received lasting fame in the western world thanks to the Venetian explorer Marco Polo's description of it in his celebrated book *Travels* (c. 1298).
- Distant and mysteriously lost Xanadu, thus, came to represent a place of mystery, splendid luxury and easy living.
- Fortunately, you get to visit Xanadu only during Packet classes and Packet exercises.
- Only use an XNDxxx tactical call that has been specifically assigned to you for an exercise or training event and then only for the duration of that event, including any homework follow-up.
- **PLEASE NEVER USE** XNDxxx tactical calls during any other time. Instead, use one of your City's extra tactical calls for practice (with your EC's permission, of course).



How to process high volume traffic efficiently

COUNTY EOC PACKET STATION SETUP & OPERATIONS

© Copyright 2011-2023 Santa Clara County ARES®/RACES. All rights reserved.

9

Packet Net Operations at County EOC

- County message handling can be non-stop action
- Have separate send & receive stations
- Learn to use the automation
 - Automated polling every 5 minutes by Telnet
 - Automated ICS 309 Logging
- Watch message handling order
- Move the messages to the Traffic Manager as quickly as possible
- Balance outgoing and incoming traffic
- Follow the *SCCo Radio Room packet procedures*

SCCo Packet Net

Reference Binder

What's inside

- There is a “standardized” binder for every position in the SCC EOC, including *each position in the RACES radio room*.
- The **Packet Net** binder contains the material from the previous binder, with updates in progress.
- General content includes:
 - activation and operation
 - end-of-shift and demobilization
 - Packet-specific activities

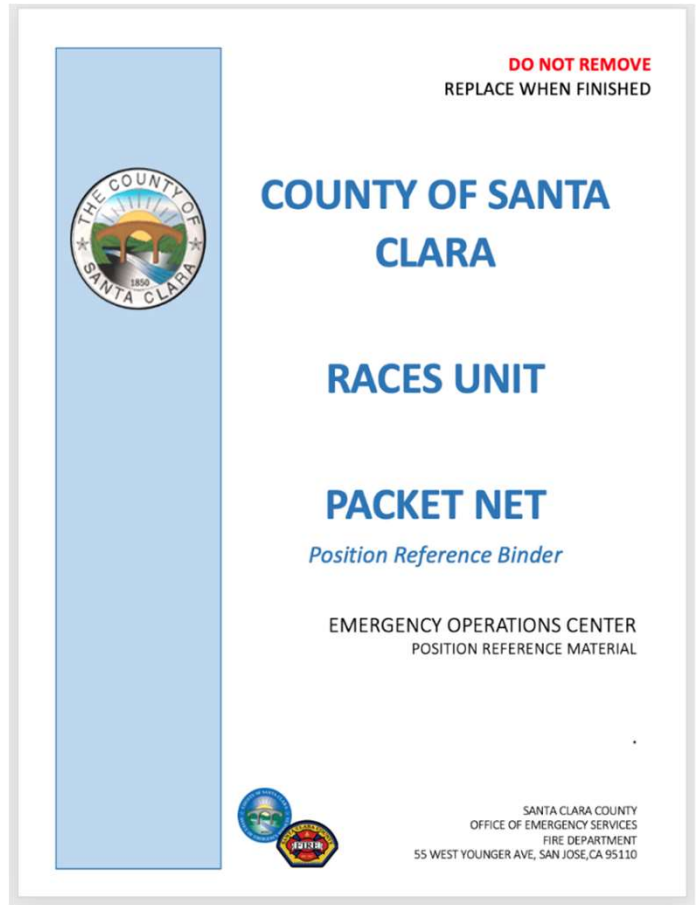

County Radio Room Traffic Routing

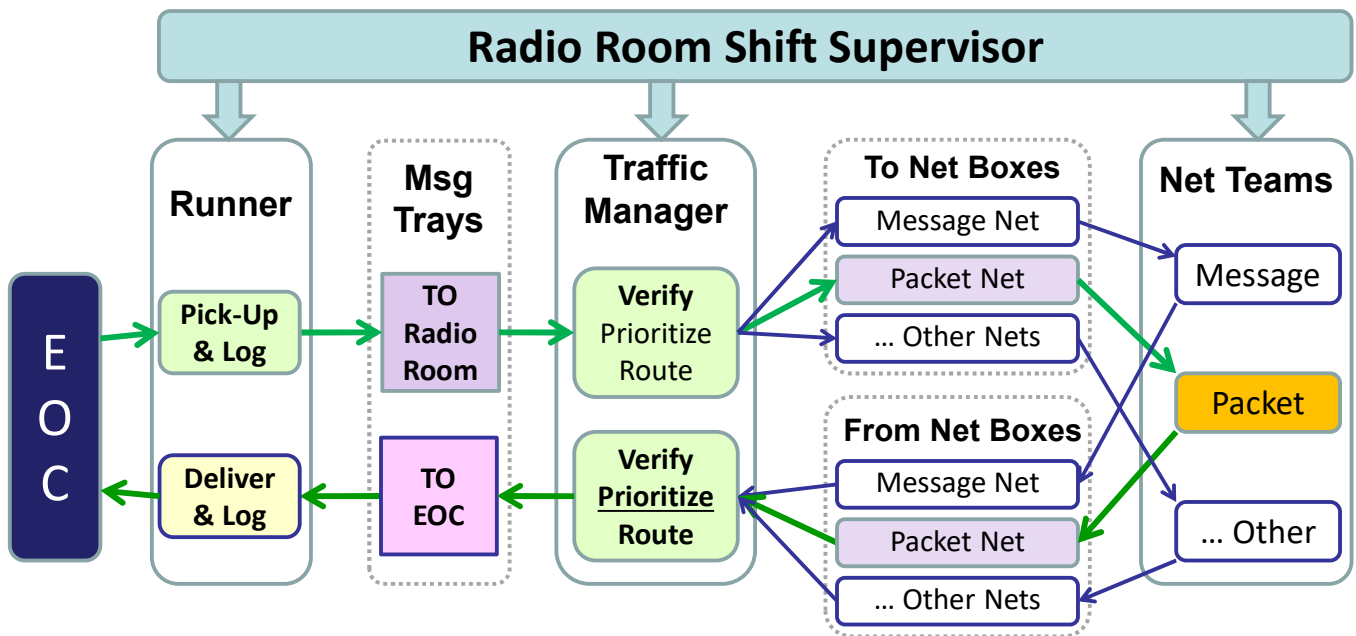

- For small, low traffic events, radio room supervisor may also perform the traffic manager role

Prioritizing Packet Traffic

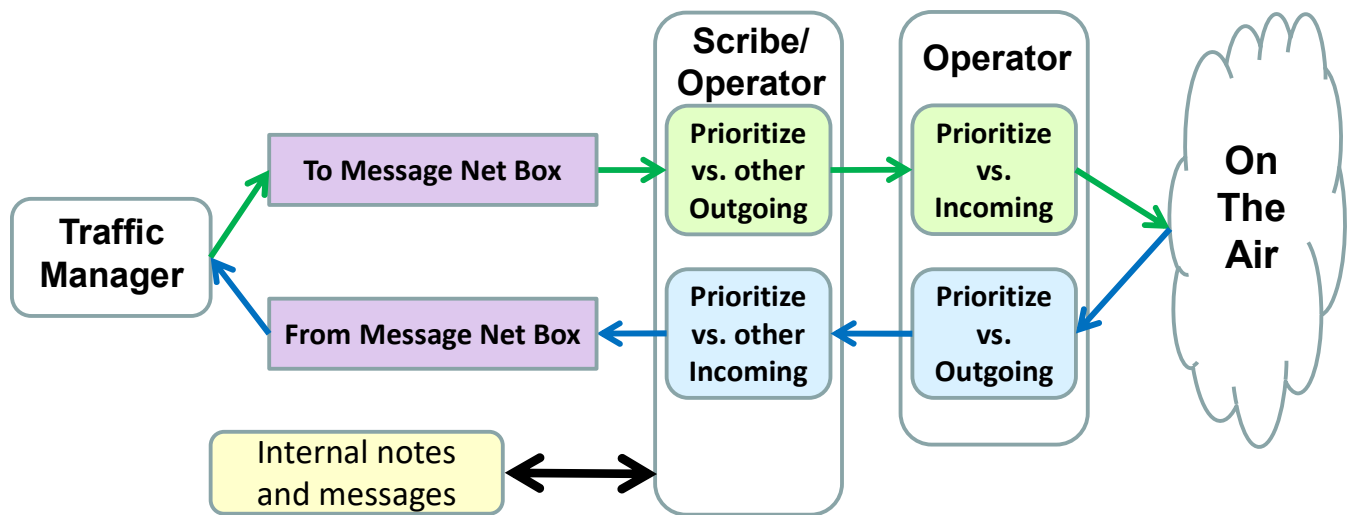

- Operator prioritizes message in Outpost
 - Holds incoming for high priority outgoing and vice versa
- Scribe/Operator prioritizes & logs message in to & out from the team
 - Maintains prioritized incoming and outgoing message bins
- Separate Send & Receive stations facilitate processing

County EOC Packet Station Overview

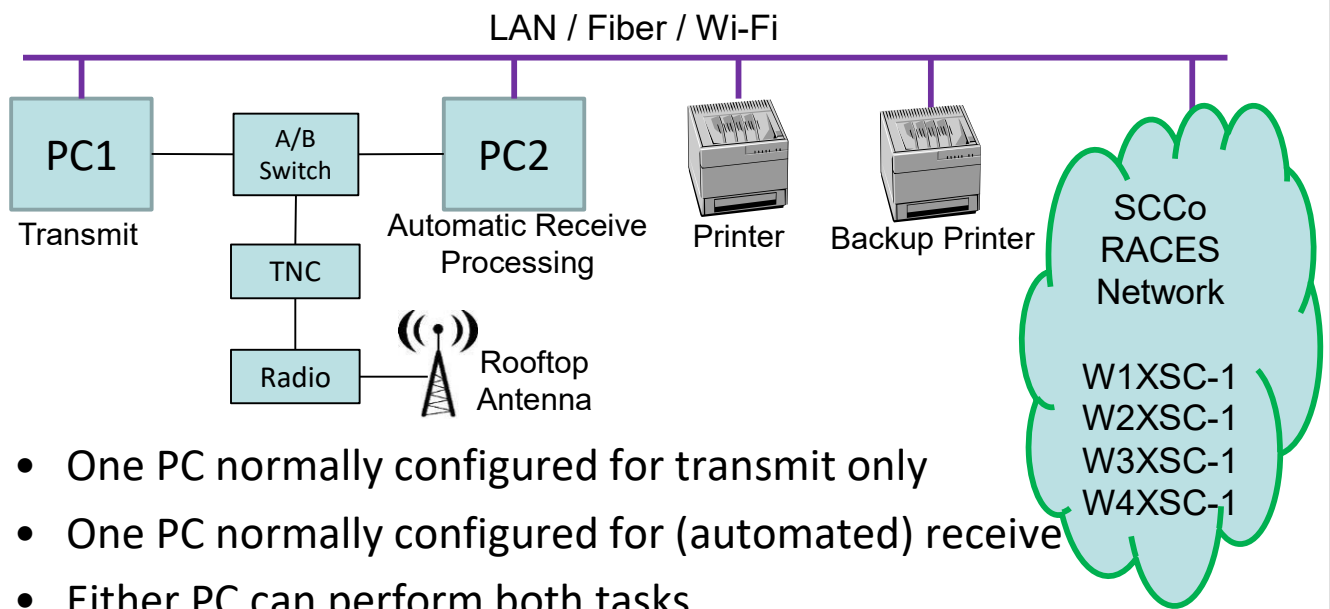

- One PC normally configured for transmit only
- One PC normally configured for (automated) receive
- Either PC can perform both tasks
- Both PCs have a primary and backup printer defined
- Backup TNC/radio can be switched to either PC



INTERACTING WITH THE BBS WITHOUT OUTPOST

© Copyright 2011-2023 Santa Clara County ARES®/RACES. All rights reserved.

15

Its all about control with Text Commands

- Simple text commands control the **TNC**
 - **MYCALL** *callsign* = set the TNC's Mycall command to your *callsign*
 - **CD** *software* = set **C**arrier **D**etect mode to software
 - **C** *callsign* = **C**onnect to station *callsign* (ax.25 address)
- Simple text commands control the **BBS** mailbox
 - **SP** *address* = **S**end a **P**ivate message to an *address*
 - **LA** = **L**ist **A**ll messages in this area (mailbox)
 - **R** *n* = **R**ead message number *n*
- Outpost simply automates the process of typing the commands to the TNC (to connect) and then to the BBS (to send/receive messages)
 - Watch the Outpost session window to see what it's doing
 - View the Outpost transaction log later to see what it did
 - Actions > View Outpost Data Directories > logs > transactionYYMMDD.log

Sidebar: Outpost Logs

From Outpost: *Actions > View Outpost data directory > logs*

```

session211015.log - Notepad
-----
15-Oct 09:34:40: Outpost/Opsessn v3.5.0 c0: TNC Session # 3019
-----
15-Oct 09:34:40: Using Call Sign KN6PE
15-Oct 09:34:40: Using TNC setup XSC_Kantronics_KPC3-Plus
15-Oct 09:34:40: Using BBS setup XSC_W1XSC-1
15-Oct 09:34:40: TncCheck: TNC is ok
15-Oct 09:34:47: TncInit: Complete as KN6PE
15-Oct 09:34:50: BbsConnect: Connected to W1XSC-1 as user KN6PE
15-Oct 09:34:50: BbsConnect: BBS is JNOS
15-Oct 09:34:50: BbsDeleteMsgs: Done
15-Oct 09:34:50: BbsSendMsgs: Done
15-Oct 09:34:50: BbsSendMsgs: Done
15-Oct 09:35:03: BBSGetMsgs: Done
15-Oct 09:35:17: BBSGetMsgs: Done
15-Oct 09:35:17: BbsSendMsgs: Done
15-Oct 09:35:19: BbsDisconnect: BBS Session closed

```

```

transaction211015.log - Notepad
-----
15-Oct 09:34:40: Outpost/Opsessn v3.5.0 c0: TNC Session # 3019
-----
cmd:D
Can't DISCONNECT, A Link state is: DISCONNECTED
cmd:b
BEACON EVERY 0 (disabled)
cmd:Echo on
ECHO was ON
cmd:my KN6PE
cmd:Mon off

STREAMEV was OFF
cmd:STREAMSW $00
STREAMSW was $7C (|)
cmd:connect W1XSC-1
cmd:*** CONNECTED to W1XSC-1
[JNOS-2.0k.2.xsc.4-B1FHIM$]
You have 0 messages.
(#0) >
A XSCPERM
xscperm: 6 messages - 6 new.
(#1) >

```

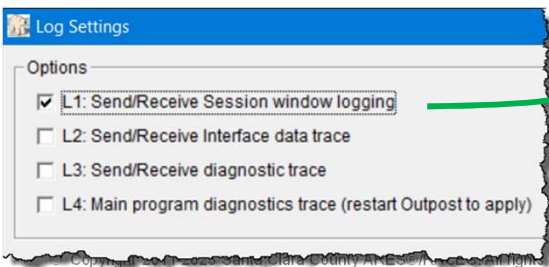

FYI...Log Settings has L1 selected by default
Optional: select L2 for additional info

Everything Can Be Done Manually

- Why would I want to/need to?
 - Outpost is not installed or installed incorrectly; no administrative access to PC
 - Browse the BBS to read bulletins
 - Gain deeper understanding of how packet radio works
 - Perform clean up or diagnostic activities on your setup or to maintain the BBS
- All you need is a terminal emulator program
 - Suggested: PuTTY (free download) <https://www.putty.org/>
... or just do an Internet search for “PuTTY”
 - But any terminal emulator will do ...
- The following examples will use PuTTY
 - Select and copy: highlight/select (not <ctrl>C)
 - Paste: Right-click (not <ctrl>V)

Summary of Steps to be Discussed

- What you need to know to operate without Outpost
- Setting up PuTTY for BBS access (serial)
- The connection basics
 - Start of shift: Configure optimized TNC settings
 - Per session: Using you FCC call sign, -OR-
 - Per session: Using a tactical call sign (plus your FCC call sign)
 - End of shift: Restore default TNC settings
- Managing Messages on JNOS
 - Access user and bulletin areas (mailboxes)
 - Read a message
 - Send a message
- Reading notices and bulletins on JNOS
- Working with PackItForms

What you need to know

Operations without Outpost

1. Connect Parameters
2. TNC Standard Settings and Manual Workflow
3. TNC User Commands
4. TNC Init Settings
5. BBS User Commands
6. BBS Init Settings

1. Three Connect Parameters

Operations without Outpost... need to know

- **Call Sign or Tactical Call of the user**

example : W6XRL4

XNDEOC

- **TNC Comm Port Settings**

example : COM3,9600,8,N,1

COM5,9600,7,E,1

- **BBS Connect Name**

example : W1XSC-1

W3XSC-1

2. TNC Standard Settings

Operations without Outpost ... need to know

- SCCo RACES determined the optimum TNC parameters for our BBS system that significantly improves message traffic throughput.
- Document contains parameters for both **Outpost** and **Manual** sessions. Details of each parameter are explained.
- See: <https://www.scc-ares-races.org/data/packet/index.html> → Application Notes → Standard TNC Parameter Settings

... and specifically the section titled: *Standard TNC Settings for Manual BBS Sessions*

2. TNC Standard Settings

Operations without Outpost ... need to know

Santa Clara County ARES®/RACES

Home Services Operations Data Training & Events Reference About October 26, 2020

Packet BBS Service

Overview | Service & Network | Presentations | Software | App Notes | Reference | Nets | Support

Packet BBS Service Notices

- 2019-07-12 - General Release of SCCo Packet Installer v145C
- 2019-05-07 - Pre-Release of SCCo Packet Installer v145F

[Previous Packet BBS Service Update History](#)

Overview

The Santa Clara County ARES/RACES network provides a standard amateur radio packet BBS (Bulletin Board System) service. The service provides full-service BBS functionality (messages and bulletins) throughout Santa Clara County even if the entire Internet is completely down. The service can also send and receive e-mail to/from Internet e-mail addresses. But the service is not in any way dependent on the Internet.

Service and Network Info

[Packet BBS Service Description](#)

Application Notes

Configuration and Set-up Instructions

- [Standard Outpost Configuration Instructions - 08/04/2018 \(PDF - 427 KB\)](#)
- [Standard TNC Parameter Settings - 04/07/2016 \(PDF - 509 KB\)](#)
- [JNOS Settings for Outpost - 06/17/2014 \(PDF - 127 KB\)](#)
- [How to Request Tactical Calls - 08/28/2016 \(PDF - 172 KB\)](#)
- [How to Configure Outpost for Inbound Message Numbering - 09/11/2010 \(PDF - 93 KB\)](#)
- [How to Configure Outpost for Automated ICS-309 Printing - 09/11/2010 \(PDF - 97 KB\)](#)

[Operation and Use Instructions](#)

Standard TNC Parameter Settings Rev: 07-Apr-2016

Standard TNC Parameter Settings for Santa Clara County Packet Network

Updated for SCCo Packet Installer v102

Table of Contents

- Introduction 3
- Fictitious Call Signs 3
- Standard TNC Settings for Outpost Users 4
 - Preconfigured TNC in Outpost 4
 - Creating an Outpost TNC Command List 4
- Standard TNC Settings for Manual BBS Sessions 13
 - Manual Operations Workflow 13
 - TNC Commands for Manual Operations 15
- Explanation of TNC Parameters 19
 - Restore Factory Defaults 19
 - Full Command Set 19
 - Mute Control 19
 - Character Length 20
 - Station Identification 21
 - Channel Access 23
 - Transport and Session Control 25
 - Radio Timing 26
 - Flow Control 27
 - Packetization Control 27
 - Stream Control 29
 - GPS Control 30
- Other TNCs 32
 - AEA PK-232MBX 32

Santa Clara County ARES®/RACES Page 1 of 34

2. Manual Operations

- Complete manual ops info
- Workflow
 - Start of Shift
 - Each message
 - End of Shift
- TNC-specific Commands

Standard TNC Parameter Settings Rev: 07-Apr-2016

Standard TNC Parameter Settings for Santa Clara County Packet Network

Updated for SCCo Packet Installer v102

Table of Contents

Introduction	3
Fictitious Call Signs	3
Standard TNC Settings for Outpost Users	4
Preconfigured TNCs in Outpost	4
Creating an Outpost TNC Command List	4
Standard TNC Settings for Manual BBS Sessions	13
Manual Operations Workflow	13
TNC Commands for Manual Operations	15
Explanation of TNC Parameters	19
Restore Factory Defaults	19
Full Command Set	19
Mode Control	19
Character Length	20
Station Identification	21
Channel Access	23
Transport and Session Control	25
Radio Timing	26
Flow Control	27
.....	27
.....	29
.....	30
.....	32
.....	32

Standard TNC Settings for Manual BBS Sessions	13
Manual Operations Workflow	13
TNC Commands for Manual Operations	15

3. Eight TNC user commands

Operations without Outpost (Kantronics KPC-3+)

1. **HELP** [command]
When entered alone, lists all available commands. With a command, provides details on that specific command.
2. **MYCALL** xxxxxx
Tells the TNC what its' call sign is.
3. **CONNECT** call1 [via call2, call3, ...]
Call1 = Call sign of the station to be connected to. Adding "via call2..." connects to the BBS by digipeaters.
4. **CONVERS**
Puts the TNC into **Con**versational mode. Then, whatever you type is immediately transmitted.
5. **<ctrl> c**
Puts the TNC into Command Mode. Then, enter TNC commands at the prompt.
6. **RESTORE DEFAULT**
Resets the TNC to the factory default settings; performs the AUTOBAUD routine. Defaults INTface to NEWUSER. Hard reset can be triggered by temporarily removing the battery.
7. **INTERFACE** [TERM | ...]
When set to TERMinal, the full command set of the TNC is available.
8. **XMITLVL** [value]
Displays or sets the TNC's transmit drive level

4. TNC Init Settings

Operations without Outpost ... need to know

- Go to the **“Standard TNC Settings for Manual BBS Sessions”**
- Follow instructions in **“Manual Operations Workflow”**
- Use the **“TNC Commands for Manual Operations”** appropriate for your particular TNC

TNC Type	Manual Ops: Start of Shift	Manual Ops: End of Shift
Kantronics KPC-3+	INTERFACE TERMINAL MONITOR OFF CD SOFTWARE NEWMODE ON 8BITCONV ON BEACON EVERY 0 SLOTTIME 10 PERSIST 63 PACLEN 128 MAXFRAME 2 FRACK 6 RETRY 8 CHECK 30 TXDELAY 40 XFLOW OFF STREAMEV OFF STREAMSW \$00	STREAMSW \$7C

5. Eight BBS user commands

<https://scc-ares-races.org> > Data Networking > Packet BBS > Reference > JNOS BBS Information

Santa Clara County ARES/RACES

Home Operations Data > Packet Training and Events Reference FAQ October 29, 2018

JNOS Packet BBS Information

Overview

The Santa Clara County BBS network uses the JNOS BBS software. This includes W1XSC, W2XSC, W3XSC, W4XSC, W5XSC, and W6XSC.

JNOS User Information

- Mailbox User Commands [from Appendix A of the JNOS Commands Manual] (PDF - 61 kB) 

JNOS Sysop Information

- JNOS 2.0 web site
 - JNOS Release Notes
 - JNOS Commands Manual
 - JNOS Downloads
 - The simplest way to get started is to use the JNOS Installer (see section "Installers for JNOS")
 - You will need to compile the installer. Links to the installer source file and instructions are provided.
 - You'll also need to compile the JNOS program. Links to the source files, instructions and release notes are provided.
- nos-bbs -- TAPR xNOS Mailing List
 - This is where all xNOS issues are discussed. Any JNOS sysops should be on this list.
- NOSintro - TCP/IP over Packet Radio - An Introduction to the KA9Q Network Operating System, by Ian Wade, G3NRW (PDF - 22 MB)
 - 356 pages, ISBN 1-897649-00-2
 - Occasionally available in paperback from Amazon and other book sellers. Posted here with permission from the author.
 - This is the definitive book on xNOS and a must-have for any JNOS sysop. The picture on page 144 is particularly helpful for understanding how messages and addresses are handled.

[Web Site Home Page](#)

JNOS User Manual – Appendix A

APPENDIX A

JNOS MAILBOX USER COMMANDS

The following commands are available to the users connected to the mailbox. This file is available separately as mboxcmds.txt.

AREA

The Area command lists the mail areas that contain messages you may read.

A gives a short listing, whereas
AF gives a full listing with descriptions (if available)
AN shows areas that have new mail since you last logged off.

To read messages in one of the areas, type '**A** <areaname>'. You will then be told how many new, not previously listed messages there are in this area.

You can send mail to any of the listed areas as '**S** <areaname>'

BYE

The **Bye** command is used to exit from the JNOS MBOX. This will close your mailbox file and remove any messages that you have deleted with the **K**[ill] command.

CONNECT

The Connect command has the following modes :

C[onnect] [port] [callsign] [<digipeater> . . .]

Connects to station 'callsign' on interface 'port', possibly via digipeaters 'digipeater...' (note the use of 'via' is optional!)

C[onnect] [node]

Connects over netrom to a remote node with 'node' as either node-call or node-alias

CONV [<channel>]

This (if available) puts you in converse mode. This is a roundtable discussion feature. The 'channel' allows specifying the conference channel you wish to join. Channel default = 0.

DOWNLOAD

D[ownload] [/] [<path_name>/]filename

Sends a plain ASCII text file.

DM

Download the motd (message of the day) which is otherwise unavailable once you get into the mbox.

Page 1 | 11

5. Eight BBS user commands

Operations without Outpost ... need to know

1. **HELP** [command] or ?

When entered alone, generates a summary of available commands. With a command as a parameter, provides details on that command.

H List = shows all the List command options and what they do

2. **LIST**

L = by itself will display the headers for all **unread** messages, if any.

LA = List **ALL** messages, both **read** and **unread**

LM = Lists **MY** messages addressed to me

L> addr = Lists all messages that have "addr" in the **To:** field of the message

3. **READ #**

= The message number to be displayed.

4. **KILL #**

= The message number to be deleted.

5. **AREA** [Area_name]

A = Lists all available bulletin areas.

AF = Gives a full listing with descriptions of areas.

A area_name = moves you to that area. Then use the **List** and **Read** commands to view messages.

5. Eight BBS user commands

Operations without Outpost ... need to know

6. **SEND** [option] <dest_address>
S[P] = Send Private; *example:* SP w6xrl4@w5xsc.ampr.org
SB = Send Bulletin; *example:* SB xsctest
SC = Send Copy; to multiple destination addresses
 example: SC w6xrl4@w5xsc.ampr.org
 (BBS then prompts with Cc: for all other addresses)
7. **BYE**
Disconnects from the BBS
8. **XM** #
displays or sets the page length for viewing messages

6. BBS Init Settings; Page Length

Operations without Outpost ... need to know

- The BBS “XM” command displays or sets the page length
 - **XM** = displays the current page length setting
 - **XM 24** = sets the page length to 24 lines
 - **XM 0** = turns off pagination (required when using Outpost)
- If a page length is set, message listings, messages and other content longer than the page length are paused and a “More (N=no)?” prompt is shown.
 - Press <ENTER> to see the next page; ‘n’ to stop
 - Good for reading content on the screen
 - Will cause Outpost to hang if not set back to XM 0
- Note: The SCCo Packet Installer includes **XM 0** in the BBS Init Commands for all SCCo BBSs. Outpost will send **XM 0** as soon as it connects to the BBS so message output is never paused.

SETTING UP PUTTY FOR BBS ACCESS

© Copyright 2011-2023 Santa Clara County ARES®/RACES. All rights reserved.

31

Serial Access

Setting up PuTTY

Install and run PuTTY

1. Select the **Session** tab
2. Select Connection Type = "Serial"
3. Enter the Com Port
 - Verify with Windows Device Manager
4. Enter the Speed (baud rate)

NOTE: Not all TNCs use 9600,8,N,1 as the configuration. All fields must match what you actually have set in your TNC.

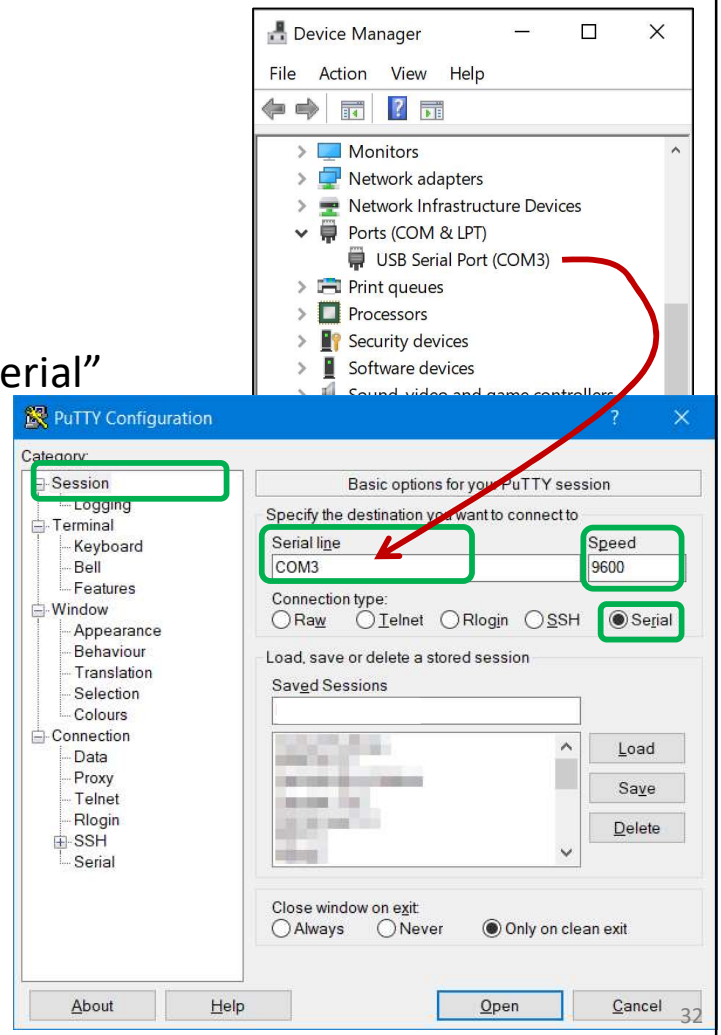

© Copyright 2011-2023 Santa Clara County ARES®/RACES. All rights reserved.

Set up Session Logging

Setting up PuTTY

5. Next, click on the **Session > Logging** tab
6. Set Session Logging to All session output
7. Set up a
NOTE: &H does not work on Windows
8. ... if the file exists:
 Always append to the end

Why do logging at all?

- During manual operations, it is easy to loose track of what is going on.
- Logging creates a history of your manual interactions and a reference if you ever need to go back and check if you got it all right.

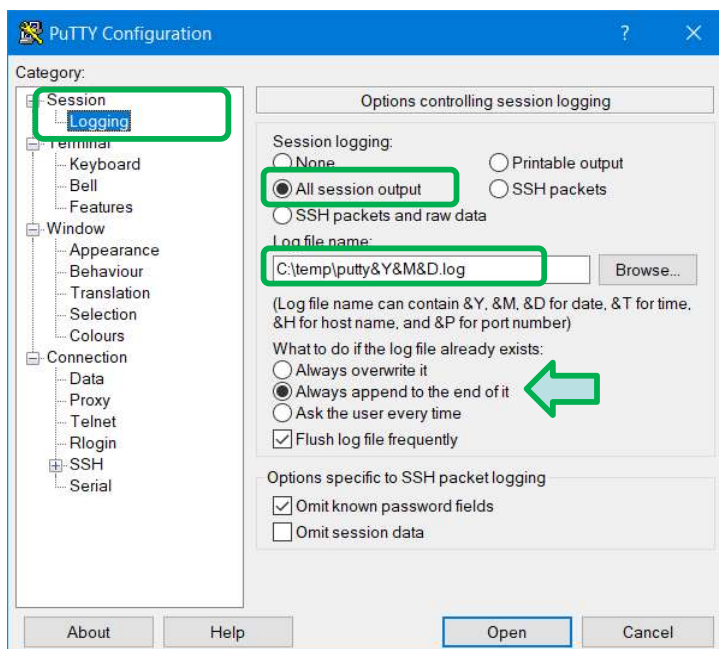

Change PuTTY's Backspace Key

Setting up PuTTY

- Next, click on the **Terminal > Keyboard** tab

The PuTTY default does not send the backspace key code that the KPC-3+ expects. To correct this:

- Set the Backspace key option to **Control-H**

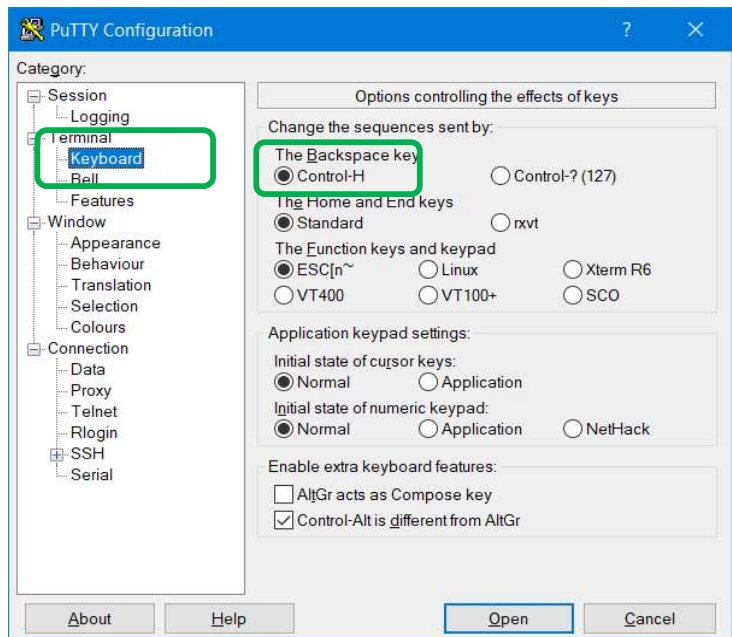

Serial Access

Setting up PuTTY

11. Next, click on the...
Connection > Serial tab
12. Set Flow control to
RTS/CTS

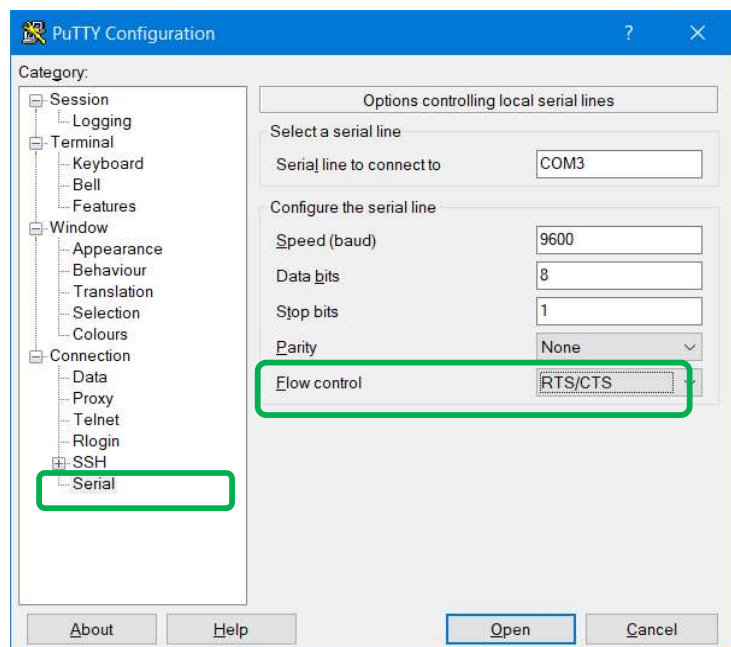

Name it, Save it, and Open it

Setting up PuTTY

13. Finally, click on the...
Session tab
14. Give this session a name
15. Press **Save**
16. Press **Open** to open the connection

NOTE: If you ever change any setting, remember to press **Save**!

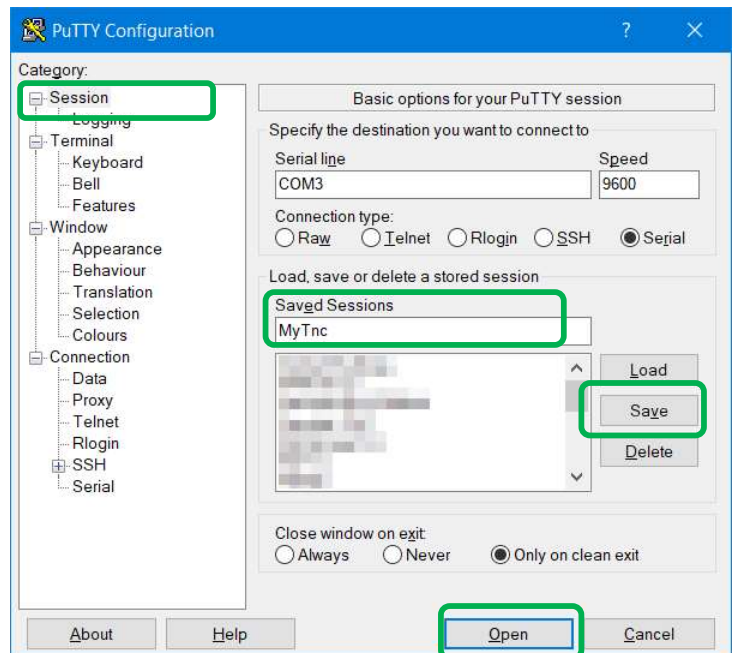

THE CONNECTION BASICS

© Copyright 2011-2023 Santa Clara County ARES®/RACES. All rights reserved.

37

Start of Shift: Configure TNC settings

The connection basics

- Outpost configures the TNC at the start of each Send/Receive session
- For manual operation, you only need to send these commands once, at the start of your shift

NOTE: Manual Ops commands are slightly different from the Outpost list of commands.

TNC Type	Manual Ops: Start of Shift	Manual Ops: End of Shift
Kantronics KPC-3+	INTERFACE TERMINAL MONITOR OFF CD SOFTWARE NEWMODE ON 8BITCONV ON BEACON EVERY 0 SLOTTIME 10 PERSIST 63 PACLEN 128 MAXFRAME 2 FRACK 6 RETRY 8 CHECK 30 TXDELAY 40 XFLOW OFF STREAMEV OFF STREAMSW \$00	STREAMSW \$7C

Start of Shift: Configure TNC settings

The connection basics

- Create and save a text file with the “Start of Shift” and “End of Shift” TNC commands.

CAUTION: Do NOT cut-and-paste directly from the PDF into your terminal emulator; *it doesn't always work.*

****Best practice:** copy the commands first into a text editor (Notepad), save it, and then copy-and-paste from there into your terminal program.

- To send the “Start of Shift” TNC commands,
 - Connect to the TNC with PuTTY
 - Select and copy the entire “Start of Shift” command list from the text file
 - Paste it into Putty (right-click) at the TNC cmd: prompt.

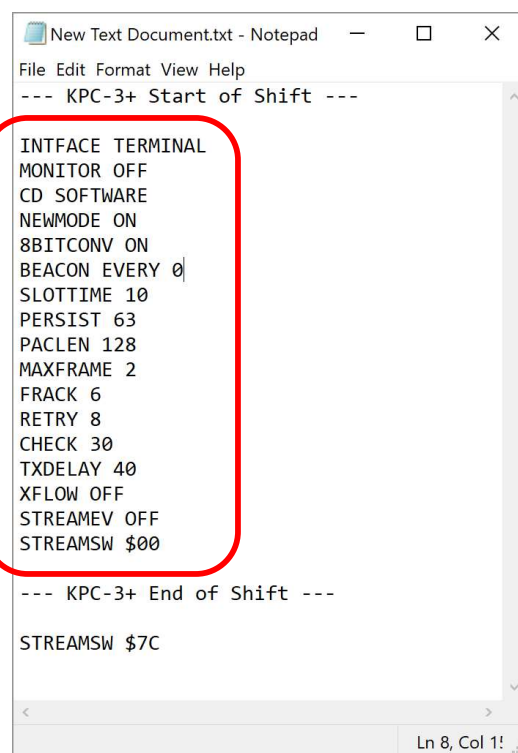

```
New Text Document.txt - Notepad
File Edit Format View Help
--- KPC-3+ Start of Shift ---

INTERFACE TERMINAL
MONITOR OFF
CD SOFTWARE
NEWMODE ON
8BITCONV ON
BEACON EVERY 0
SLOTTIME 10
PERSIST 63
PACLEN 128
MAXFRAME 2
FRACK 6
RETRY 8
CHECK 30
TXDELAY 40
XFLOW OFF
STREAMEV OFF
STREAMSW $00

--- KPC-3+ End of Shift ---

STREAMSW $7C

Ln 8, Col 1!
```

During the Shift: FCC Call Sign Session

The connection basics

```

1 cmd:mycall w6xrl4
2 cmd:c w5xsc-1
3 cmd:*** CONNECTED TO W5XSC-1
4 [JNOS-2.0k.1.xsc.2-B1FHIM$]
5 You have 0 messages.
6 (#0) >
7 b
8 *** DISCONNECTED
9 cmd:

```

**Note: All SCCo BBSs have
a 2 minute Inactivity Timer!**

- On the TNC:
 1. Set **MYCALL** to your FCC call sign
 2. **CONNECT** to the BBS / mailbox service (SSID=1) on W5XSC
 3. Connected message from TNC
- On the BBS:
 4. BBS says it is a JNOS BBS, version is 2.0k.1.xsc.2, with options
 5. You have no messages
 6. BBS Prompt: You are on message #0
 7. You type "**B**" (bye) to terminate the BBS session
The BBS drops the connection
- On the TNC:
 8. Disconnected message from the TNC
 9. TNC is ready for the next command

FCC Call Sign Session – On the Air

The connection basics

FROM

TO

AX25: W6XRL4->W5XSC-1 CONNECT

AX25: W5XSC-1->W6XRL4

DATA: [JNOS-2.0k.1.xsc.2-B1FHIM\$] .You have 0 messages..(#0) >.

AX25: W6XRL4->W5XSC-1

DATA: b.

AX25: W5XSC-1->W6XRL4 DISCONNECT

Note: Protocol codes have been removed

- FROM and TO addresses of all packets contain legal call signs
- Both stations are meeting the FCC identification requirements with every packet (more than required)

During the Shift: Tactical Call Sign Session

The connection basics

```

1 cmd:mycall xndec
2 cmd:c w5xsc-1
3 cmd:*** CONNECTED TO W5XSC-1
4 [JNOS-2.0k.1.xsc.2-B1FHIM$]
5 You have 0 messages.
6 (#0) >
7 b
8 *** DISCONNECTED
9 cmd:conv
  This is w6xrl4
10 cmd:

```

**Note: All SCCo BBSs have
a 2 minute Inactivity Timer!**

- On the TNC:
 1. Set **MYCALL** to your **tactical** call sign
 2. **CONNECT** to the mailbox service (SSID=1) on W5XSC
 3. Connected message from TNC
- On the BBS:
 4. BBS says it is a JNOS BBS, version 2.0k.1.xsc.2, with IHM\$ options
 5. You have no messages
 6. BBS Prompt: You are on message #0
 7. You type "**B**" (bye) to terminate the BBS session
The BBS drops the connection
- On the TNC:
 8. Disconnected message from the TNC
 9. Enter **CONVerse** mode, and then type in at least your FCC call sign, press enter to transmit
 10. Enter **Cntl-C** to return to Command Mode.
TNC is ready for the next command

Tactical Call Sign Session – On the Air

The connection basics

FROM

TO

AX25: XNDEOC->W5XSC-1 CONNECT

AX25: W5XSC-1->XNDEOC CONNECT

DATA: [JNOS-2.0k.1.xsc.2-B1FHIM\$].You have 0 messages.(#0) >.

AX25: XNDEOC->W5XSC-1

DATA: B.

AX25: W5XSC-1->XNDEOC DISCONNECT

Note: Protocol codes have been removed

AX25: XNDEOC->CQ

DATA: This is w6xrl4.

The extra converse mode packet lets you identify your station XNDEOC as FCC call sign W6XRL4

- XNDEOC is not a legal call sign
- Keep session under 10 minutes and use ID process at the end of session to satisfy the FCC requirements.

End of Shift: Restore TNC settings

The connection basics

- After the BBS session has disconnected, you should be back to the TNC command prompt, usually: cmd:
- When your shift is finished and before you pack up the gear or turn it over to someone else, return the TNC to “normal” settings
- Cut-and-paste the “End of Shift” Send/Receive settings into PuTTY at the TNC command prompt

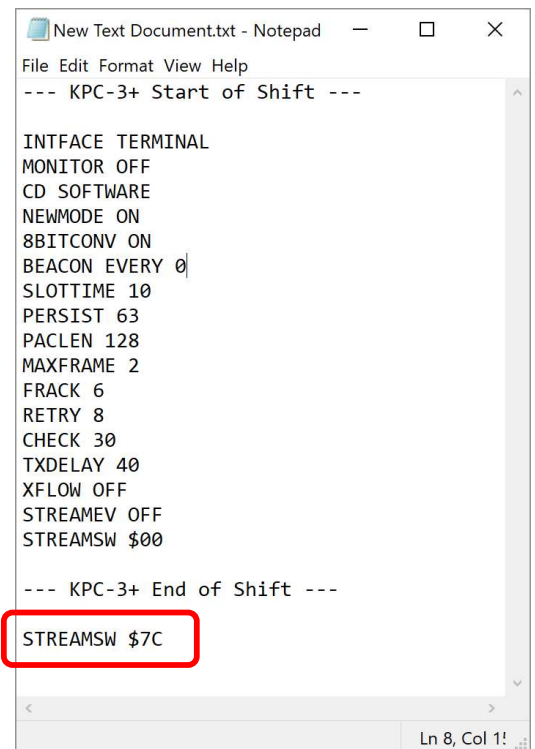

```
New Text Document.txt - Notepad
File Edit Format View Help
--- KPC-3+ Start of Shift ---

INTERFACE TERMINAL
MONITOR OFF
CD SOFTWARE
NEWMODE ON
8BITCONV ON
BEACON EVERY 0
SLOTTIME 10
PERSIST 63
PACLEN 128
MAXFRAME 2
FRACK 6
RETRY 8
CHECK 30
TXDELAY 40
XFLOW OFF
STREAMEV OFF
STREAMSW $00

--- KPC-3+ End of Shift ---
STREAMSW $7C
Ln 8, Col 1!
```

MANAGING MESSAGES WITH JNOS COMMANDS

© Copyright 2011-2023 Santa Clara County ARES®/RACES. All rights reserved.

46

BBS Connect & Login

- Ready to connect to BBS
- Set your call (FCC or tactical) in the TNC for login

cmd: MYCALL W6XRL4 Or cmd: MYCALL XNDEOC

- Connect

cmd: C W5XSC-1

- JNOS gets login info from MYCALL
- No login prompt needed

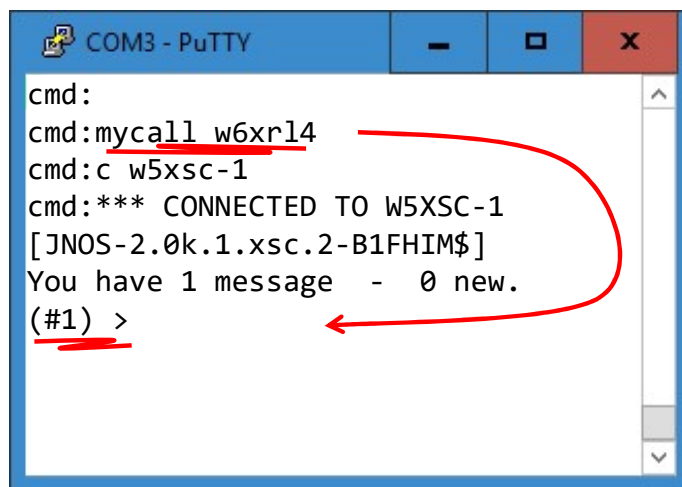
A screenshot of a PuTTY terminal window titled "COM3 - PuTTY". The terminal shows the following text: "cmd:", "cmd:mycall w6xr14", "cmd:c w5xsc-1", "cmd:*** CONNECTED TO W5XSC-1", "[JNOS-2.0k.1.xsc.2-B1FHIM\$]", "You have 1 message - 0 new.", and "(#1) >". Red annotations include underlines under "mycall w6xr14" and "(#1)", and a red arrow pointing from the underlined "mycall w6xr14" to the underlined "(#1)".

```
cmd:
cmd:mycall w6xr14
cmd:c w5xsc-1
cmd:*** CONNECTED TO W5XSC-1
[JNOS-2.0k.1.xsc.2-B1FHIM$]
You have 1 message - 0 new.
(#1) >
```

HELP

JNOS Commands

- Basic commands can be seen with HELP command

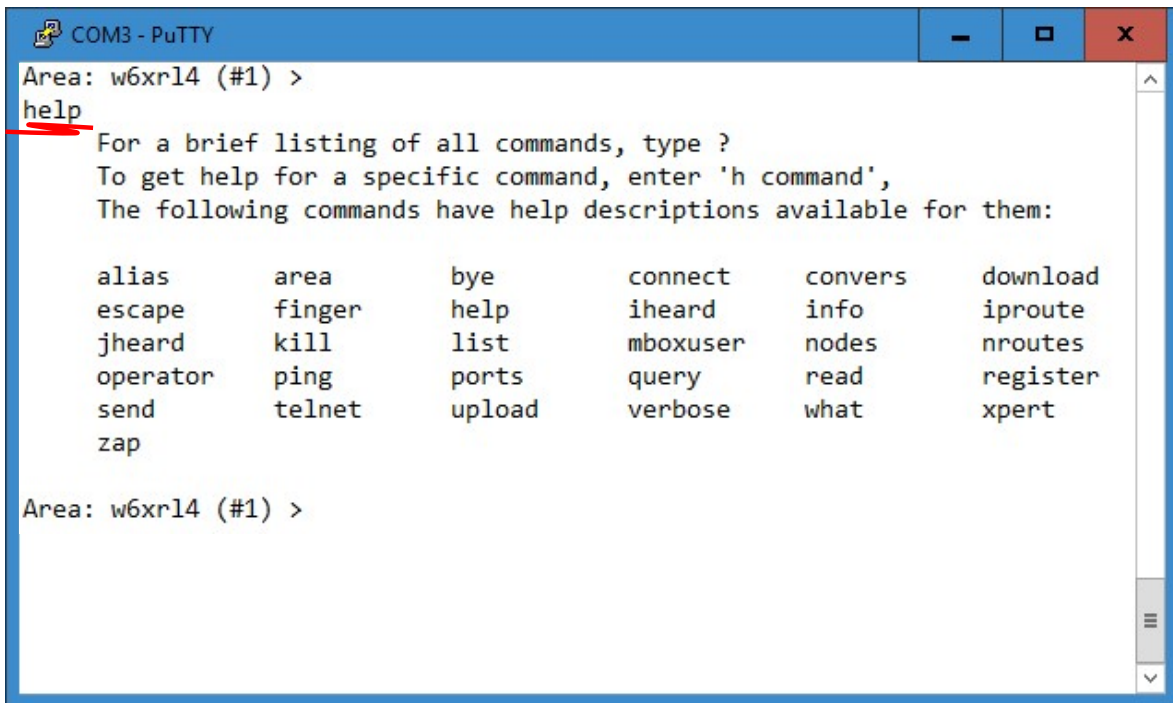

The screenshot shows a PuTTY terminal window titled "COM3 - PuTTY". The prompt is "Area: w6xr14 (#1) >". The user has entered the command "help", which is underlined in red. The output of the command is as follows:

```
Area: w6xr14 (#1) >
help
For a brief listing of all commands, type ?
To get help for a specific command, enter 'h command',
The following commands have help descriptions available for them:

alias      area      bye      connect  convers  download
escape     finger   help     iheard   info     iproute
jheard     kill     list     mboxuser nodes     nroutes
operator   ping     ports    query    read     register
send       telnet   upload   verbose  what     xpert
zap
```

The prompt "Area: w6xr14 (#1) >" is visible again at the bottom of the terminal window.

HELP <command>

JNOS Commands

- Help with the command will give a detailed explanation

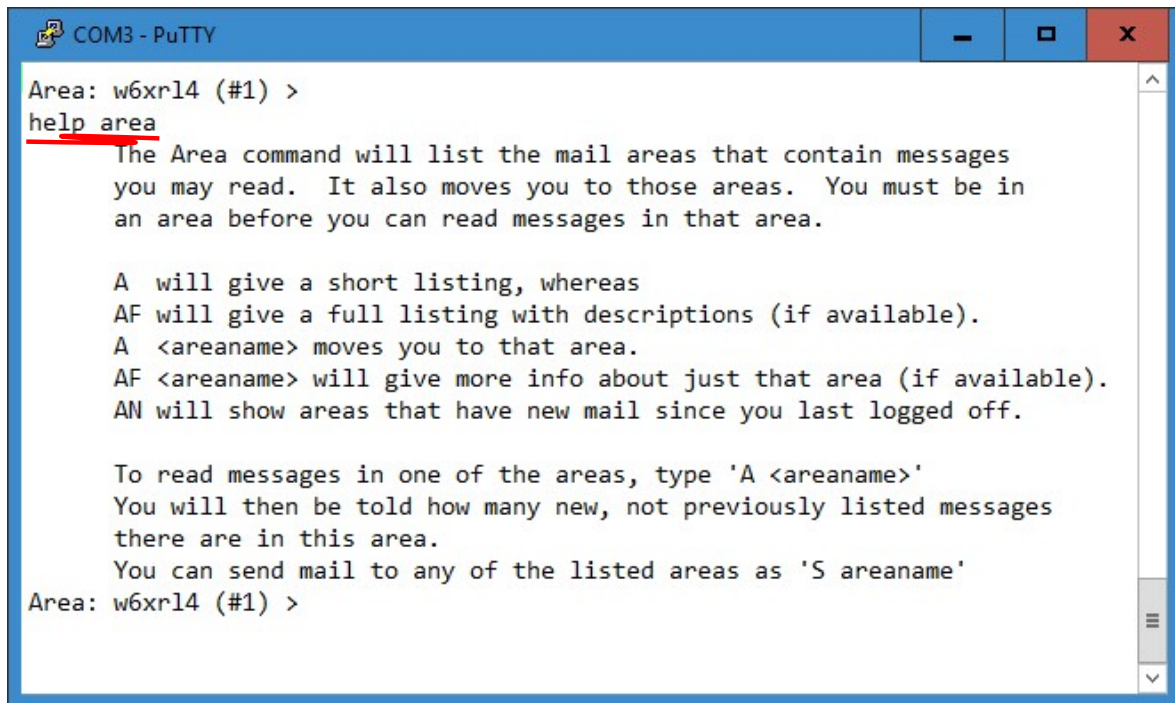

```
COM3 - PuTTY
Area: w6xrl4 (#1) >
help area
The Area command will list the mail areas that contain messages
you may read. It also moves you to those areas. You must be in
an area before you can read messages in that area.

A will give a short listing, whereas
AF will give a full listing with descriptions (if available).
A <areaname> moves you to that area.
AF <areaname> will give more info about just that area (if available).
AN will show areas that have new mail since you last logged off.

To read messages in one of the areas, type 'A <areaname>'
You will then be told how many new, not previously listed messages
there are in this area.
You can send mail to any of the listed areas as 'S areaname'
Area: w6xrl4 (#1) >
```

AREA

JNOS Commands

- Messages are organized in **AREAs**
 - Your mailbox is an area
 - Bulletins: xscperm, xscevent, xsctest are each their own AREA

A[rea] gives a short listing, whereas ...

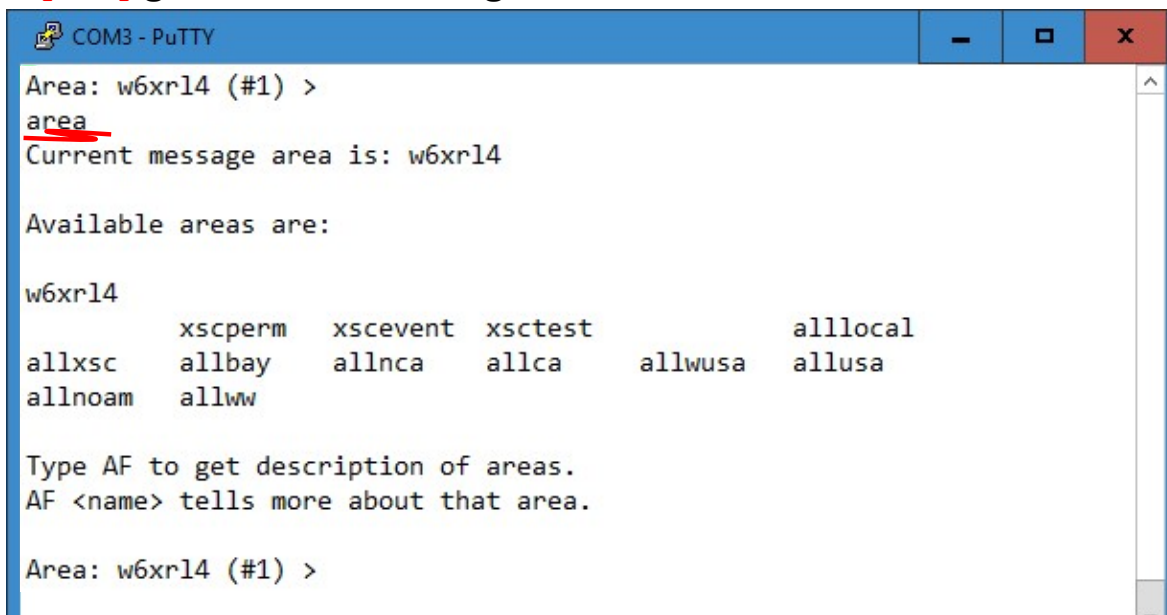

```
COM3 - PuTTY
Area: w6xr14 (#1) >
area
Current message area is: w6xr14

Available areas are:

w6xr14
      xscperm  xscevent  xsctest   alllocal
allxsc  allbay   allnca   allca    allwusa  allusa
allnoam  allww

Type AF to get description of areas.
AF <name> tells more about that area.

Area: w6xr14 (#1) >
```

AREA

JNOS Commands

AF gives a full listing with descriptions (if available)

```

COM3 - PuTTY
Area: w6xr14 (#1) >
af
Current message area is: w6xr14

Available areas are:

w6xr14      Your private mail area

# Santa Clara County Op Area Shared Mailboxes
xscperm     Operation, Configuration and other Permanent Info   (To: xscperm)
xscevent    Emergency Incident and Public Service Event Info       (To: xscevent)
xsctest     Test and Training                                       (To: xsctest)

# General Bulletin Areas by Distribution
alllocal    All categories, this BBS only (no distribution)         (To: <cat>@local)
allxsc      All categories, Santa Clara Co distribution              (To: <cat>@xsc)
allbay      All categories, SF & Monterey Bay distribution           (To: <cat>@bay)
allnca      All categories, Northern California distribution         (To: <cat>@nca)
allca       All categories, California distribution                  (To: <cat>@ca)
allwusa     All categories, Western USA distribution                 (To: <cat>@wusa)
allusa      All categories, USA distribution                         (To: <cat>@usa)
allnoam     All categories, North America distribution               (To: <cat>@noam)
allww       All categories, Worldwide distribution                   (To: <cat>@ww)

# <cat>     A short (max 6 char) category like "quake", "flood", "wx", ...
Area: w6xr14 (#1) >
    
```

How to address an SCo Notice

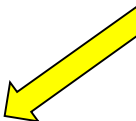

How to address a generic bulletin. Note the different format



AREA Example

JNOS Commands

- Change areas to read SCCo bulletins
 - “area xsctest” – changes to the “xsctest” area
 - “L” or “LA” – *lists* or *lists all* bulletins in that area
 - “area <callsign>” – returns you to your own area

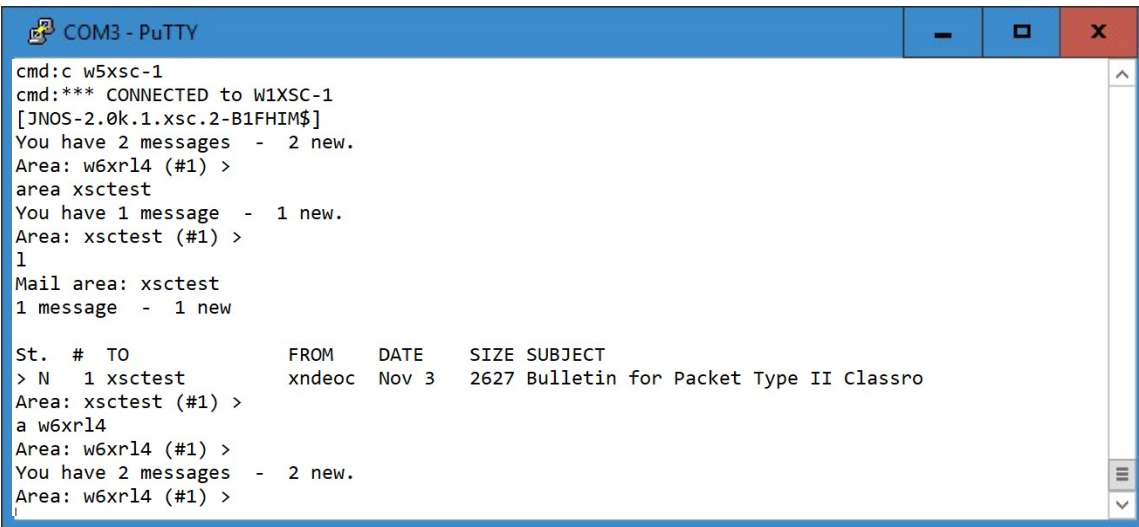

```
COM3 - PuTTY
cmd:c w5xsc-1
cmd:*** CONNECTED to W1XSC-1
[JNOS-2.0k.1.xsc.2-B1FHIM$]
You have 2 messages - 2 new.
Area: w6xr14 (#1) >
area xsctest
You have 1 message - 1 new.
Area: xsctest (#1) >
L
1
Mail area: xsctest
1 message - 1 new

St. # TO          FROM  DATE   SIZE SUBJECT
> N  1 xsctest    xndeoc Nov 3  2627 Bulletin for Packet Type II Classro
Area: xsctest (#1) >
a w6xr14
Area: w6xr14 (#1) >
You have 2 messages - 2 new.
Area: w6xr14 (#1) >
```

LIST

JNOS Commands

- Displays a list of the messages from the current mailbox (or "area")
 - L** - by itself will display the headers for all unread messages, if any.
 - LA** - list all messages, read or unread

```

COM3 - PuTTY
cmd:c w5xsc-1
cmd:*** CONNECTED to W1XSC-1
[JNOS-2.0k.1.xsc.2-B1FHIM$]
You have 2 messages - 2 new.
Area: w6xr14 (#1) >
1
Mail area: w6cr14
2 messages - 2 new

St. # TO FROM DATE SIZE SUBJECT
> N 1 w6xr14 xndeoc Nov 2 454 XND-133P_R_Jelly Donut Request
N 2 w6xr14 xndeoc Nov 2 443 XND-132P_R_Jelly Donut Delivery No
Area: w6xr14 (#1) >
    
```

READ

JNOS Commands

- **R[ead] #**
- **R[ead] <msg_number_or_range>**
- To read a specific message, you may either type "R #" or just the number by itself. RM will display all unread messages, sequentially.

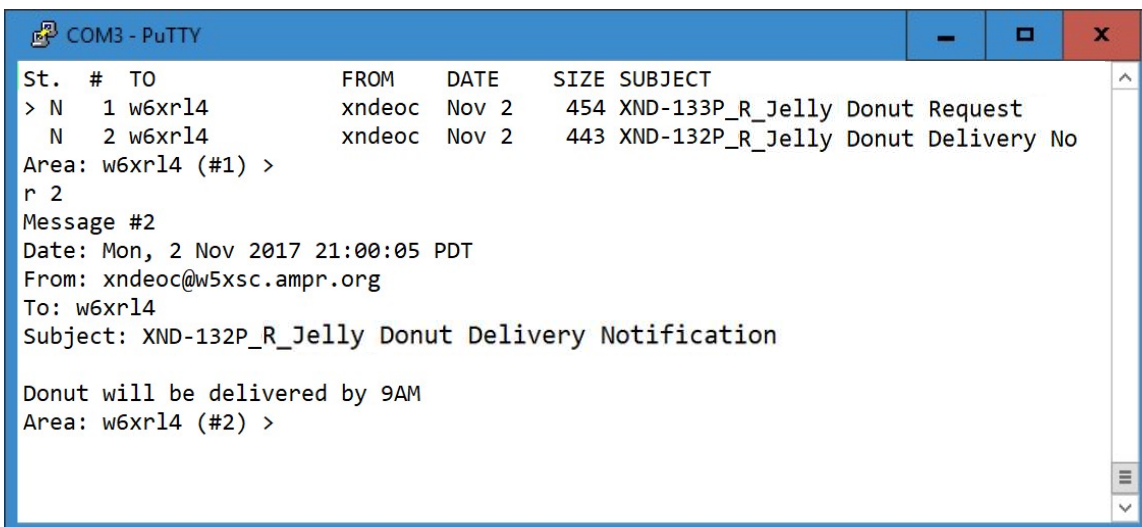

```
COM3 - PuTTY
St. # TO FROM DATE SIZE SUBJECT
> N 1 w6xr14 xndeoc Nov 2 454 XND-133P_R_Jelly Donut Request
  N 2 w6xr14 xndeoc Nov 2 443 XND-132P_R_Jelly Donut Delivery No
Area: w6xr14 (#1) >
r 2
Message #2
Date: Mon, 2 Nov 2017 21:00:05 PDT
From: xndeoc@w5xsc.ampr.org
To: w6xr14
Subject: XND-132P_R_Jelly Donut Delivery Notification

Donut will be delivered by 9AM
Area: w6xr14 (#2) >
```

© Copyright 2011-2023 Santa Clara County ARES®/RACES. All rights reserved.

54

KILL

JNOS Commands

- The **KILL** command allows you to delete messages from your mailbox
K[ill] <message_number>
- At least one message number must be supplied. The message numbers you can select from can be displayed with the "**L[ist]**" command.
- Messages will not disappear until you disconnect and connect again

SEND

JNOS Commands

- The send (S) or send private (SP) command allows you to enter a message and send it to a user

S[P] <user>@<domain> where
 <user> = recipient's name
 <domain> = <bbscall>
 <bbscall>.ampr.org
 internet domain

- Send an SCCo specific Notice

SB < NoticeArea | <category>@<distribution> >

- SCCo Notices: SB < NoticeArea >
- General purpose bulletins: SB <category>@<distribution>
- As above, but ANY <user> may read the message from the mailbox.
The < NoticeArea > may be...
 - xscperm
 - xscevent
 - xsctest

Send a Message from the Keyboard

JNOS Commands

- Connect to the BBS using a terminal program
- Use these BBS commands
 - **SP <user>@<domain>** – Send a message to a user at a specific domain.
 - When prompted, enter an SCCo standard subject
 - When prompted, type the body of message
 - When done, on the next line, add **“/EX”** and press **[Enter]**

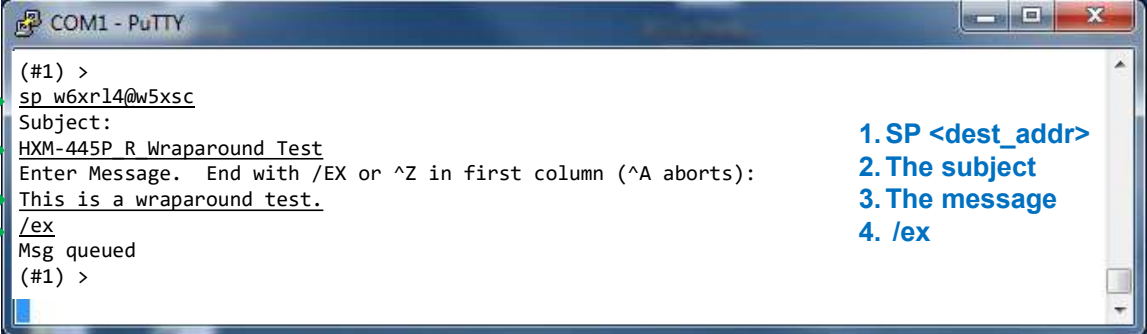

```
(#1) >
sp w6xr14@w5xsc
Subject:
HXM-445P R Wraparound Test
Enter Message. End with /EX or ^Z in first column (^A aborts):
This is a wraparound test.
/ex
Msg queued
(#1) >
```

1. SP <dest_addr>
2. The subject
3. The message
4. /ex

Send Copy

JNOS Commands

- The send copy command allows you to enter a message and send it to multiple users
 - **SC <user>@<domain>**
- Enter the send copy command with one address
- JNOS responds with “**Cc:**”
 - Enter other addresses to receive a copy, separated with commas

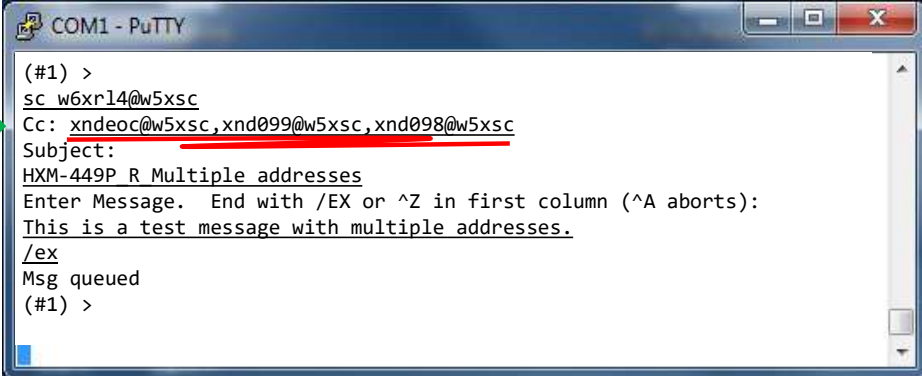

A screenshot of a PuTTY terminal window titled "COM1 - PuTTY". The terminal shows the following text:

```
(#1) >  
sc w6xr14@w5xsc  
Cc: xndeoc@w5xsc,xnd099@w5xsc,xnd098@w5xsc  
Subject:  
HXM-449P R Multiple addresses  
Enter Message. End with /EX or ^Z in first column (^A aborts):  
This is a test message with multiple addresses.  
/ex  
Msg queued  
(#1) >
```

A green arrow points to the "Cc:" line in the terminal output.

BYE

JNOS Commands

- When you are all done with the BBS, disconnect from the BBS
B[ye]
- On disconnecting
 - Outgoing messages will be processed
 - Deleted (killed) messages will be removed

Don't Forget!!!
All SCCo BBSs have a
2 minute inactivity timer!

FYI... Manual message basics

Troubleshooting Hint

- Knowing how manual packet works will help you **troubleshoot problems**.
- Sending to one destination address:

```

① sp <dest_address>
② <subject line>
③ <message line 1>
   <message line 2>
   :
   <message line n>
④ /ex
    
```

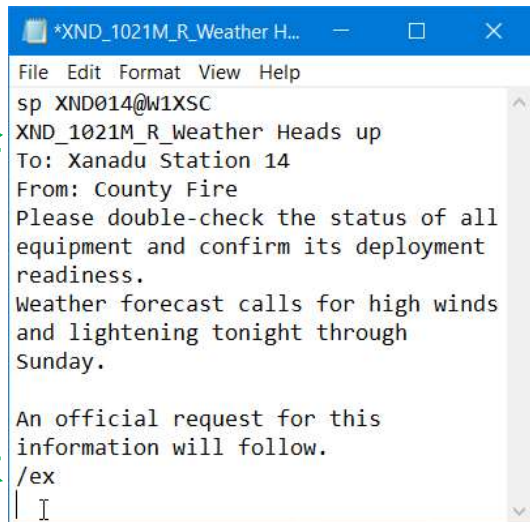

- After the SP command, the BBS prompts for the subject, then the message.
- Once the ***ENTIRE*** message sequence is created, highlight and copy all of it and then paste it into PuTTY at the BBS Prompt.

FYI... Manual message basics

Troubleshooting Hint

- Knowing how manual packet works will help you **troubleshoot problems**.
- Sending to multiple addresses:

- ① `sc <dest_address>`
- ①A `<other_addresses>`
- ② `<subject line>`
- ③ `<message line 1>`
- `<message line 2>`
- `:`
- `<message line n>`
- ④ `/ex`

```

File Edit Format View Help
sc XND014@W1XSC
XND015@W1XSC, XND071@W1XSC, XND083@W1XSC
XND_1022M_R_Weather Heads up
To: Xanadu Stations 14, 15, 71, 83
From: County Fire
Please double-check the status of all
equipment and confirm its deployment
readiness.
Weather forecast calls for high winds
and lightening tonight through Sunday.

An official request for this
information will follow.
/ex
    
```

- After the **SC** command (**Send Copy**), the BBS prompts with a **CC:** for additional destination addresses.
- Once the ***ENTIRE*** message sequence is created, highlight and copy all of it and then paste it into PuTTY at the BBS Prompt.

FYI... Manual message basics

Saving the message

- There are reasons to save the message before sending it
 - You have copy for your records.
 - You can save all your messages before sending them.
 - Avoids having to re-enter the message if something goes wrong.
- Where you save the message is up to you. But:
 - If this is your PC, then save them anywhere where you can find them.
 - If this is a shared PC, then create a directory on the C: Drive.
- For instance: your directory structure could look like this:
 - C:\MyMessages
 - C:\MyMessages\XND-23-1009T (activation number)
- Use the message subject as the name of the file.

BUT... Manual PackItForms will do a lot of this for you!

READING BULLETINS ON JNOS

© Copyright 2011-2023 Santa Clara County ARES®/RACES. All rights reserved.

Bulletin Review

Bulletins

- Bulletins are messages intended for a broad audience
- The SCCo BBSs support two types of bulletins:
 - **Notices** are a special type of bulletin specific to Santa Clara County
 - Only distributed to SCCo BBSs (W*XSC)
 - SCCo uses 3 special categories for specific content
 - General **Bulletins** are globally compatible, used for everything else
 - User-defined *category* (e.g.: “equake”, “ARES”) identifies content
 - User-defined *distribution* controls how widely it is distributed (e.g.: “XSC”, “BAY”, “NCA”, etc.).
- Regardless of the bulletin type, when configured in Outpost, Outpost will automatically download them



SCCo Notice Areas

NOTICE

Bulletins

- SCCo ARES/RACES has three special **notice** categories:
 - **xscperm**
 - Used for notices that do not expire
 - examples: standard county procedures
 - **xscevent**
 - Notices posted here automatically expire after 8 days
 - examples: Drills, public service events, incidents, other activations
 - **xsctest**
 - Good for user testing; automatically expires after 1 day
 - **allxsc**
 - Where you can write city and jurisdiction notes
 - Notices posted here automatically expire after 8 days

General Bulletins Overview

Bulletins

- Bulletins are messages that are intended for broad readership
- Bulletins content varies from amber alerts and earthquake reports to jokes and recipes
- Bulletin sender controls how widely the bulletin is distributed
 - Can be as narrow as “local” (this BBS only)
 - Can be as wide as “ww” (worldwide)!
- In JNOS, bulletins are sorted into shared areas (mailboxes) for easier reading

General Bulletins – Why Do They Matter?

Bulletins

- Standard way to distribute information between BBSs of all types throughout the world
- Use them for fun or for emergency communications
- Use them for distributing information to broader areas:
 - Santa Clara County
 - San Francisco Bay area
 - Northern California
 - All California
 - And wider ...
- Example:
 - During the 2009 cable cut, information about anticipated service restoration times were distributed via bulletins by a ham who had information from the telecom carrier

General Bulletin Addresses

Bulletins

- Address format: `category@distribution`
- **Distribution**
 - A six-character or shorter keyword which defines how widely the bulletin will be distributed
 - Sender picks from a pre-defined list
 - Acceptable distributions:
 - local Local BBS only
 - xsc XSC Operational Area (Santa Clara County)
 - bay San Francisco and Monterey Bay area
 - nca No. California (generally north of the Tahachapi Mountains)
 - ca California
 - wusa Western USA (generally, West of the Mississippi River)
 - usa United States of America
 - noam North America (Canada, USA, Mexico, ...)
 - ww worldwide

General Bulletin Addresses (continued)

Bulletins

- Address format: **category@distribution**
- **Category:**
 - A six-character or shorter description of the main topic of the bulletin.
 - Sender picks the category based on the contents of the bulletin
 - Example categories:
 - amber – Amber alerts
 - equake – Earthquake reports
 - flood – Flood reports
 - swpc – Space Weather Prediction Center
 - mtv, cup, sjc, etc. – City bulletins
 - humor or humour – Jokes, stories, etc.
 - Any category works on our SCCo BBSs because we sort bulletins by distribution, not category
 - Uncommon/unusual categories may be held on other BBSs until the sysop decides where it should go

General Bulletin Addresses (continued)

Bulletins

- Example bulletin addresses:
 - mtv@xsc
 - City of Mountain View information for distribution to all BBSs in Santa Clara County
 - flood@bay
 - Information about flooding for distribution to all BBSs in the San Francisco and Monterey Bay areas
 - equake@nca
 - Information about an earthquake for distribution to all BBSs in Northern California
 - swpc@ww
 - Space Weather Prediction Center reports for distribution to all BBSs worldwide
 - humour@ww
 - Variety of jokes and funny stories

Reading General Bulletins

Bulletins

- Use a terminal program like PuTTY
 - Read only the bulletins of interest
 - Be selective when listing and reading
- Read bulletins just like mail
 - Find out what areas are available
 - AREA
 - Select a bulletin area
 - AREA <area_name>
 - List bulletins
 - LA (list all)
 - L> <category_name> (where category_name matches the messages' **To:** field, ex: **equake@ww**)
 - Read a bulletin
 - R #

General Bulletin Example

Bulletins

1. Use "A" to change area to "allww"
2. Wow, that's a lot!
3. Set page length
XM 24
4. List All
5. JNOS pauses
 - <Enter> to continue
 - <N> to stop

- Note, there are multiple categories in the list
 - wp
 - tech
 - swpc
 - equake
 - ...

```

COM1 - PuTTY
cmd:c w5xsc-1
cmd:*** CONNECTED to WSXSC-1
[JNOS-2.0j.7t.XSC32.1-IHM$]
You have 4 messages - 3 new.
(#1) >
a allww
allww 180 messages - 180 new.
(#1) >
xm 24
(#1) >
la
Mail area: allww
180 messages - 180 new

St. # TO FROM DATE SIZE SUBJECT
> N 1 why@ww g0tez Jan 1 5679 Baloons ?
N 2 tz@ww g0tez Jan 2 10405 RE:Time Zones, etc.
N 3 wp@ww va3hra Mar 14 1434 WP Update
N 4 today@ww n0kfq Mar 14 3027 Today in History - Mar 14
N 5 swpc@ww cx2sa Mar 14 4745 Geophysical Alert Message (WWV)
N 6 swpc@ww cx2sa Mar 14 2944 Report of Solar-Geophysical Activit
N 7 equake@ww cx2sa Mar 14 1967 SOUTHWEST OF AFRICA
N 8 swpc@ww cx2sa Mar 14 3811 Daily Space Weather Indices
N 9 pic@ww ja4msm Mar 15 1919 7+ FLWR507.JPG info
N 10 wp@ww w5mcc Mar 15 1237 WP Update
N 11 wp@ww kb8oak Mar 15 1328 WP Update
N 12 wp@ww n9lcf Mar 15 2259 WP Update
N 13 wp@ww n1dot Mar 15 1104 WP Update
N 14 swpc@ww cx2sa Mar 15 1723 Solar Region Summary
N 15 fbblog@ww gb7cow Mar 15 7408 FBBLOG 10/2016 * GB7COW BBS *
N 16 swpc@ww cx2sa Mar 15 2508 Solar and Geophysical Activity Summ
N 17 wp@ww w6krf Mar 14 1159 WP Update
N 18 wp@ww ac4zr Mar 15 1429 WP Update
N 19 equake@ww cx2sa Mar 15 1938 STRAIT OF GIBRALTAR
N 20 wp@ww wa5eoc Mar 15 1440 WP Update
N 21 tech@ww g8mny Mar 15 1946 Flashing LED lamp driver
N 22 humour@ww gm3yew Mar 15 6974 Jokes 15/3
N 23 tech@ww g8mny Mar 15 6204 LED Bike Light
More (N=no) ?
    
```

Filter the General Bulletins

Bulletins

- JNOS command L> will filter the list by To: address
 - Example: L> *category*
 - ... will list only bulletins where the To: address contains *category*
- Example: list all earthquake bulletins

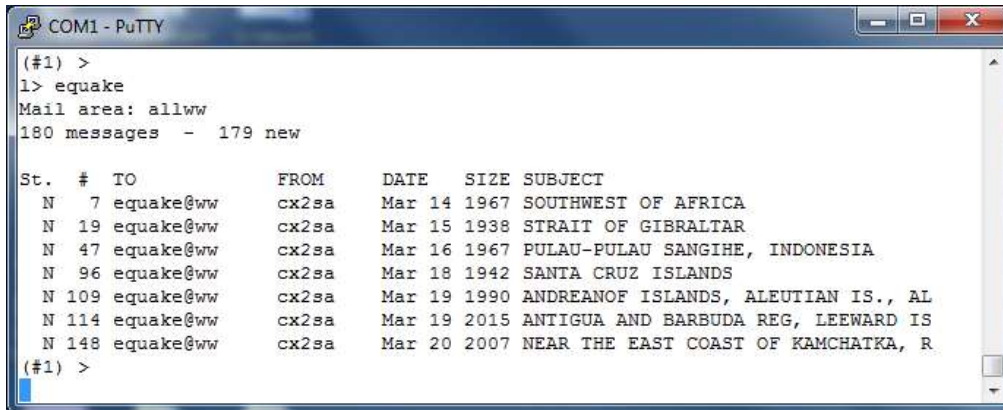

```
COM1 - PuTTY
(#1) >
l> equake
Mail area: allww
180 messages - 179 new

St. # TO FROM DATE SIZE SUBJECT
N 7 equake@ww cx2sa Mar 14 1967 SOUTHWEST OF AFRICA
N 19 equake@ww cx2sa Mar 15 1938 STRAIT OF GIBRALTAR
N 47 equake@ww cx2sa Mar 16 1967 PULAU-PULAU SANGIHE, INDONESIA
N 96 equake@ww cx2sa Mar 18 1942 SANTA CRUZ ISLANDS
N 109 equake@ww cx2sa Mar 19 1990 ANDREANOF ISLANDS, ALEUTIAN IS., AL
N 114 equake@ww cx2sa Mar 19 2015 ANTIGUA AND BARBUDA REG, LEEWARD IS
N 148 equake@ww cx2sa Mar 20 2007 NEAR THE EAST COAST OF KAMCHATKA, R
(#1) >
```

Read General Bulletins Like Messages

Bulletins

- Read using the R # command

```

COM1 - PuTTY
(#1) >
l> equake
Mail area: allww
180 messages - 179 new

St. # TO FROM DATE SIZE SUBJECT
N 7 equake@ww cx2sa Mar 14 1967 SOUTHWEST OF AFRICA
N 19 equake@ww cx2sa Mar 15 1938 STRAIT OF GIBRALTAR
N 47 equake@ww cx2sa Mar 16 1967 PULAU-PULAU SANGIHE, INDONESIA
N 96 equake@ww cx2sa Mar 18 1942 SANTA CRUZ ISLANDS
N 109 equake@ww cx2sa Mar 19 1990 ANDREANOF ISLANDS, ALEUTIAN IS., AL
N 114 equake@ww cx2sa Mar 19 2015 ANTIGUA AND BARBUDA REG, LEEWARD IS
N 148 equake@ww cx2sa Mar 20 2007 NEAR THE EAST COAST OF KAMCHATKA, R

(#1) >
r 96
Message #96
Date: 18 Mar 16 13:13:00 GMT
From: cx2sa@cx2sa.sal.ury.soam
To: equake@ww
Subject: SANTA CRUZ ISLANDS

Path: N6RME!CX2SA

From: CX2SA@CX2SA.SAL.URY.SOAM
To : EQUAKE@WW

== PRELIMINARY EARTHQUAKE REPORT ==

Region: SANTA CRUZ ISLANDS
Geographic coordinates: 12.487S, 166.531E
Magnitude: 5.5
Depth: 42 km
Universal Time (UTC): 18 Mar 2016 12:49:15
Time near the Epicenter: 18 Mar 2016 17:49:15

Location with respect to nearby cities:
189 km (117 mi) NW of Sola, Vanuatu
343 km (212 mi) NNW of Luganville, Vanuatu
611 km (378 mi) NNW of Port-Vila, Vanuatu
794 km (492 mi) ESE of Honiara, Solomon Islands
More (N=no) ?
  
```

© Copyright 2011-2023 Santa Clara County ARES®/RACES. All rights reserved.

74

But, what about PackItForms?



© Copyright 2011-2023 Santa Clara County ARES®/RACES. All rights reserved.

77

77

Submitted for your approval...

THE
PACKET
ZONE

- You just arrived at **XND Fire Station 14** to take over as Packet Operator. This is great... Your first MAC assignment!
- As you enter, the last shift Packet Op rushes past you saying...
“there’s a couple of ICS 213’s on the desk to be sent!”
- At least you won’t be bored.
- Over your shoulder, you hear him yell back...
“Oh yeah, I could never get Outpost to work after IT updated the Windows O/S... and they just left.”
- The PC is running; you click the Outpost icon... Error; and you have never seen this error before 😞
- OK, deep breaths. You know what to do, right?

Manual PackItForms

Fortunately, PackItForms is a message creation system designed to work with both Outpost or as a **standalone** solution for forms-based messages.

- ***What's new with the PackItForms 3.10***

- Enhanced standalone message management, including:
 - Manages setting up and using user and tactical IDs
 - Takes care of message numbering
 - Includes a Plain Text message form
 - Creates a standalone ICS-309 log
 - Creates copy-ready text (all BBS commands) to paste into PuTTY
 - Easy message saving

- **What's the same**

- Tight integration with Outpost
- Supports all PackItForms
- Formats a standard packet form for sending
- Processes a received packet form

Get ready for Manual PackItForms

Things to do before you get started:

1. Create a directory where you will save your messages.
2. Consider a naming convention that is relevant for your assignment, examples:
 - C:\MyMessages\X14-23-1009T (by Activation Number)
 - C:\PacketMessages\2023-10-09 (by date)
 - C:\Xanadu_Station_14 (by assignment)
3. Identify a starting message number
 - Can be any number; PackItForm will append a **M** for **Manual** to make it unique.

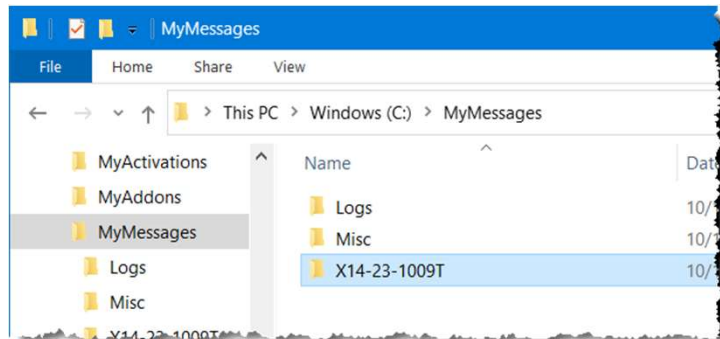

Manual PackItForm messages

Manually create a PackItForm message

1. Run PackItForms with the *manual.cmd*
2. Set up your user ID, tactical ID, and Next message number
3. Pick and fill in a PackItForm
4. Create the packet message
5. Send the message with PuTTY
6. Save a copy of the message

1. Running manual PackItForms

1. Open your File Explorer and navigate to C:\PackItForms\Outpost\SCCo
2. Find the file ***manual.cmd***, and run it (double-click on it)

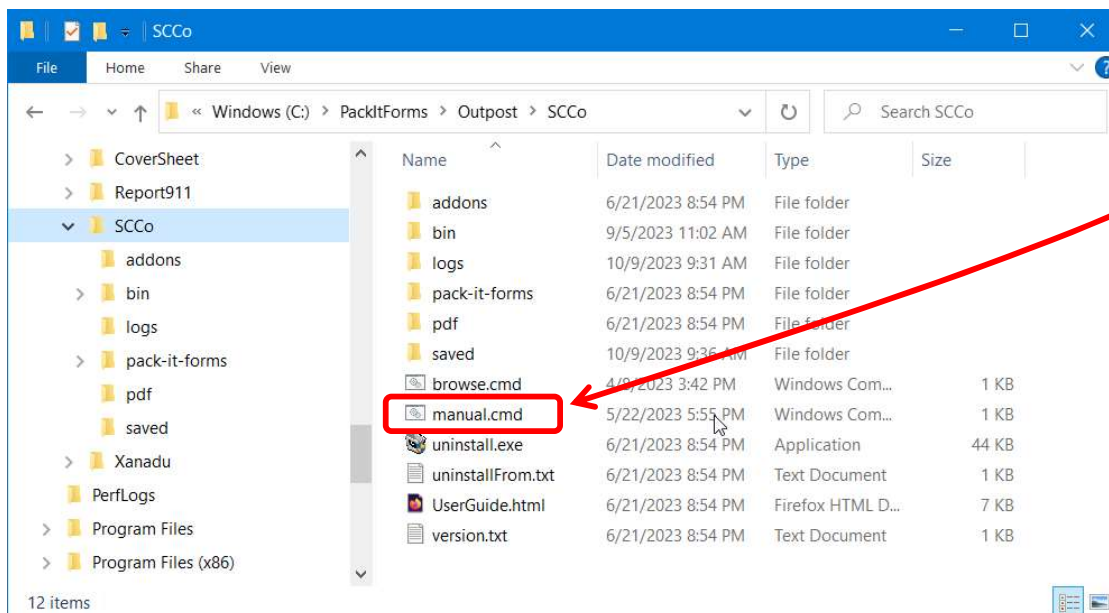

© Copyright 2011-2023 Santa Clara County ARES®/RACES. All rights reserved.

82

82

2. Set up manual PackItForm

Setup Page

The setup page loads when you first start.

3. Fill in or update all fields:
 - Your user information
 - Tactical Call information
 - Next Message Number

FYI... User and Tactical Call information will persist from run to run.

FYI... The Next Message Number will increment automatically.

4. Press **OK** when done

The screenshot shows a web browser window with the following content:

- Browser tabs: SCCo PackItForms, Setup PackItForms
- Address bar: 127.0.0.1:64874/text
- Page title: Santa Clara County ARES/RACES PackItForms
- Form fields:
 - User Call Sign: W6XRL4
 - User Name: Herman Munster
 - Message ID Prefix: RL4 (3 characters max)
 - Use Tactical Call Sign
 - Tactical Call Sign: XND014
 - Tactical Name: Fire Station 14
 - Message ID Prefix: X14 (3 characters max)
 - Next Message Number: 304
- Buttons: OK, Cancel

3. Pick and fill in a form

Home Page

Consists of 2 sections and a series of controls:

- **Setup button:** Opens the Setup page.
- **Edit ICS-309 Log:** lets you make updates to the manual ICS-309 Log.
- **Create a message to send.** Choose a PackItForm message, then press **Create Message**
- **View a received message.** Paste in a received message, then press **Log and View**

File Edit View History Bookmarks Tools Help

SCCo PackItForms

127.0.0.1:64874/manual 110%

Santa Clara County ARES/RACES PackItForms PIF: 2.1

Setup Edit ICS-309 Log

Create a message to send

Message type:

Create Message

View a received message

Enter the received message, including the From, Subject and other headers. You can paste, drag and drop or upload a file.

Message:

Upload

Download

!SCCoPIFO!
#T: ...
MsgNo: [XYZ-123P]
...
!/ADDON!

Received Date: Time:

Log and View Reset Fields

3. Pick and fill in a form

Home Page

5. From the dropdown menu, select a **PackItForm**,

- plain text
- XSC Check-In/Out Message
- XSC ICS-213 Message
- XSC EOC-213RR Resource Request
- XSC OA Jurisdiction Status
- XSC OA Shelter Status
- XSC Allied Health Facility Status
- XSC RACES Mutual Aid Request

then:

6. Press **Create Message**

The PackItForm opens with the usual fields filled in.

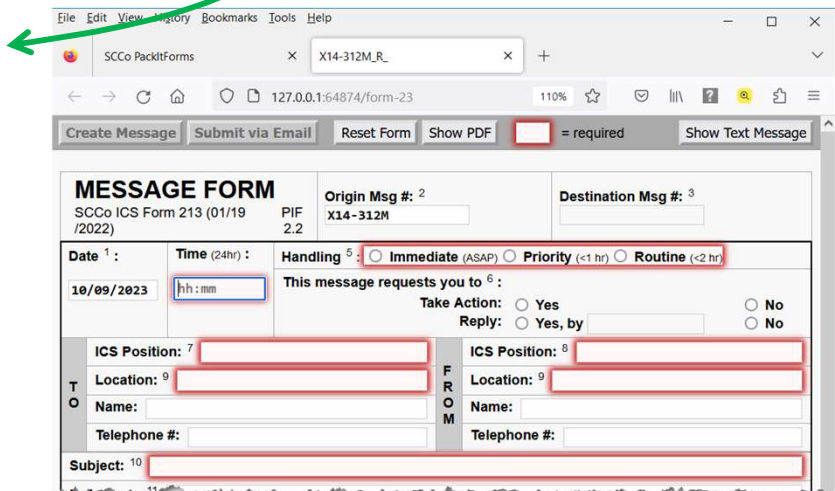
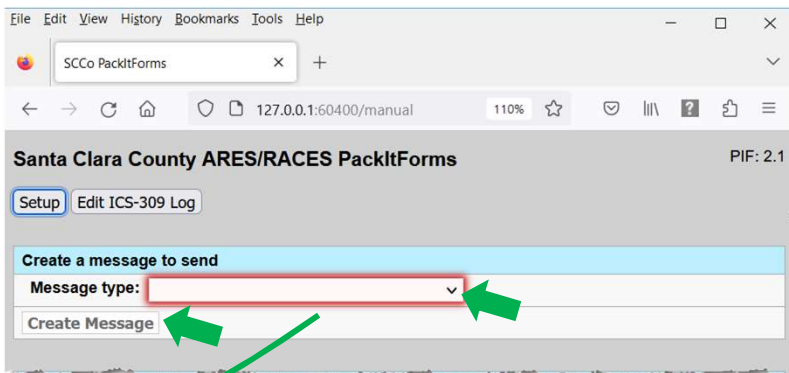

3. Pick and fill in a form

Creating a message

On the selected PackItForm,
7. Fill in the form as usual.

NOTE: The Message ID is set with the **M** suffix;

Origin Msg #: 2
X14-312M

PackItForms takes care of this for you.

8. When done, press
Create Message

The screenshot shows a web browser window with the URL 127.0.0.1:64874/form-24. The browser's address bar and navigation buttons are visible. Below the browser, there is a green navigation bar with buttons: 'Create Message' (highlighted with a red box), 'Submit via Email', 'Reset Form', 'Show PDF', and 'Show Text Message'. The main content area is titled 'MESSAGE FORM' and contains the following fields:

- Origin Msg #:** 2 (with a small '2' superscript), value: X14-312M
- Destination Msg #:** 3
- Date:** 10/09/2023
- Time (24hr):** 17:10
- Handling:** Immediate (ASAP) Priority (<1 hr) Routine (<2 hr)
- Take Action:** Yes No
- Reply:** Yes, by No
- ICS Position:** 7 Logistics
- ICS Position:** 8 Station Caption
- Location:** 9 Xanadu EOC
- Location:** 9 Xanadu Fire Station 14
- Name:**
- Telephone #:**
- Subject:** 10 Equipment Status
- Reference:** 11 e.g. Number of earlier msg.
- Message:** 12 All equipment is ready for deployment.
- CC:** Management Operations Planning Logistics Finance
- Operator Use Only:** 14
- Relay:** Rcvd: Sent:
- How Received:** Telephone Dispatch Center
- How Received:** EOC Radio FAX Courier
- How Received:** Amateur Radio Other: Packet
- Operator Call Sign:** W6XRL4
- Operator Name:** Herman Munster
- Date:** {{date}}
- Time:** {{time}}

4. Create the packet message

Message Page

On the Message Page,

9. If needed, check the box if this message is **Urgent** or a **Bulletin** .

10. In the **To:** field,

- enter the Destination address
- multiple addresses, separate with commas.

11. When done, press **Log and Send**

The screenshot shows a web browser window with the title 'SCCo PacketForms'. The address bar displays '127.0.0.1:64874/manual-message-24'. The page content includes:

- Urgent:** **Bulletin:**
- To:** XNDEOC@w1xsc.ampr.org
- Subject:** X14-312M_R_IC213_Equipment Status
- Message:** !SCCoPIFO!
#T: form-ics213.html
#V: 3.11-2.2
MsgNo: [X14-312M]
1a.: [10/09/2023]
1b.: [20:16]
5.: [ROUTINE]
- Log and Send** button

Green arrows point from the text instructions to the 'To:' field and the 'Log and Send' button.

4. Create the packet message

BBS Command Page

The complete packet-ready text is ready for sending.

12. Copy the text. Put your mouse cursor in the text area, and then either:
- From the browser menu,
 - Edit > Select All**
 - Edit > Copy**
 - or enter --
 - **<ctrl>-a <ctrl>-c**
(same as the menus)

Reminder: PackItForm creates a properly formatted Subject line... do not change this!

```

File Edit View History Bookmarks Tools Help
SCCo PackItForms X 127.0.0.1:64874/text-24/X14-312M_ X
127.0.0.1:64874/text-24/X14-312M_R_IC5213
SP XNDEOC@w1xsc.ampr.org
X14-312M_R_IC5213_Equipment Status
!SCCoPIFO!
#T: form-ics213.html
#V: 3.11-2.2
MsgNo: [X14-312M]
1a.: [10/09/2023]
1b.: [20:16]
5.: [ROUTINE]
7.: [Logistics]
8.: [Station Caption]
9a.: [Xanadu EOC]
9b.: [Xanadu Fire Station 14]
10.: [Equipment Status]
12.: [All equipment is ready for deployment.]
Rec-Sent: [sender]
OpCall: [W6XRL4]
OpName: [Herman Munster]
Method: [Other]
Other: [Packet]
OpDate: [10/09/2023]
OpTime: [20:17]
!/ADDON!
/EX
  
```

5. Send the message

What are the Steps?

13. Make sure you previously copied the packet message from the **BBS Command Page** (previous page)
14. Start PuTTY
15. Connect to the BBS
16. Once at the BBS prompt:
 - Put the cursor in the PuTTY text area after the BBS prompt, and then
 - **Mouse *right-click*** to paste in the message.

The complete packet-ready text is pasted into PuTTY and will start being transmitted to the BBS.

Reminder:

All SCCo BBSs have a 2-minute inactivity timer!

5. Send the message

BBS Command Page

```

File Edit View History Bookmarks Tools Help
SCCo PacketForms x 127.0.0.1:64874/text
127.0.0.1:64874/text-24/

SP XNDEOC@w1xsc.ampr.org
X14-312M_R_ICS213_Equipment Status
!SCCoPIFO!
#T: form-ics213.html
#V: 3.11-2.2
MsgNo: [X14-312M]
1a.: [10/09/2023]
1b.: [20:16]
5.: [ROUTINE]
7.: [Logistics]
8.: [Station Caption]
9a.: [Xanadu EOC]
9b.: [Xanadu Fire Station 14]
10.: [Equipment Status]
12.: [All equipment is ready for deployment.]
Rec-Sent: [sender]
OpCall: [W6XRL4]
OpName: [Herman Munster]
Method: [Other]
Other: [Packet]
OpDate: [10/09/2023]
OpTime: [20:17]
!/ADDON!
/EX
    
```

© Copyright 2011-2023 Santa Clara County ARES®/RACES. All rights reserved.

PuTTY Screen

```

192.168.51.10 - PuTTY
(#1) >
SP XNDEOC@w1xsc.ampr.org
X14-312M_R_ICS213_Equipment Status
!SCCoPIFO!
#T: form-ics213.html
#V: 3.11-2.2
MsgNo: [X14-312M]
1a.: [10/09/2023]
1b.: [20:16]
5.: [ROUTINE]
7.: [Logistics]
8.: [Station Caption]
9a.: [Xanadu EOC]
9b.: [Xanadu Fire Station 14]
10.: [Equipment Status]
12.: [All equipment is ready for deployment]
Rec-Sent: [sender]
OpCall: [W6XRL4]
OpName: [Herman Munster]
Method: [Other]
Other: [Packet]
OpDate: [10/09/2023]
OpTime: [20:17]
!/ADDON!
/EX
To: XNDEOC@w1xsc.ampr.org
Subject:
Enter message. End with /EX or ^Z in first
column (^A aborts)
Msg Queued
(#1) >
    
```

6. Save the message

BBS Command Page

Back at this page,

17. Put your mouse cursor in the text area, and then:

- From the browser menu, **File > Save As**
-- or --
- **<ctrl>-s** (same as menu)

18. If not shown, navigate to the PackItForm save directory previously created.

PackItForm sets the file name to the listed subject.

19. Press **Save**.

```

File Edit View History Bookmarks Tools Help
SCCo PackItForms x 127.0.0.1:64874/text-24/X14-312M_ICS213
← → ↻ 🏠 🛡️ 📄 127.0.0.1:64874/text-24/X14-312M_ICS213
SP XNDEOC@w1xsc.ampr.org
X14-312M_R_ICS213_Equipment Status
!SCCoPIFO!
#T: form-ics213.html
#V: 3.11-2.2
MsgNo: [X14-312M]
1a.: [10/09/2023]
1b.: [20:16]
5.: [ROUTINE]
7.: [Logistics]
8.: [Station Caption]
9a.: [Xanadu EOC]
9b.: [Xanadu Fire Station 14]
10.: [Equipment Status]
12.: [All equipment is ready for deployment.]
Rec-Sent: [sender]
OpCall: [W6XRL4]
OpName: [Herman Munster]
Method: [Other]
Other: [Packet]
OpDate: [10/09/2023]
OpTime: [20:17]
!/ADDON!
/EX
  
```

A note on manual plain text messages

- Yes, PackItForms does support manual Plain Text message sending and receiving.
- After picking plain text message from the **Home Page**, the **Message Page** opens up.
- Message ID and Handling order are filled in, **DO NOT REPLACE THIS!**
- Fill in...
 - To: destination packet address
 - the rest of the Subject text
 - Your plain text message
- Finally, press **Log and Send**
- The rest of the send process is the same.

The screenshot shows a web browser window with the address bar displaying '127.0.0.1:56660/manual-message-'. The page contains a form with the following fields:

- Urgent:**
- Bulletin:**
- To:** a comma-separated list
- Subject:** X16-1251M_R_Equipment Status
- Message:** (empty text area)

At the bottom of the form is a green button labeled 'Log and Send'. Red and blue arrows from the text on the left point to the 'Subject' field.

Manual PackItForm messages

Receiving messages

1. Read messages from the BBS using PuTTY
2. Save the message
3. Once you have the message saved, delete the message off of the BBS (use the **Kill #** command)

Note: All SCCo BBSs have a 2-minute inactivity timer!

Receive manual messages

PuTTY Screen

```

COM10 - PuTTY
(#1) >
r 1
Message #1
Date: Mon, 9 Oct 2023 20:26:51 PST
From: xndx14@w1xsc.ampr.org
To: xndeoc@w1xsc
Subject: X14-312M_R_IC213_Equipment Status

!SCCoPIFO!
#T: form-ics213.html
#V: 3.11-2.2
MsgNo: [X14-312M]
1a.: [10/09/2023]
1b.: [20:16]
5.: [ROUTINE]
7.: [Logistics]
8.: [Station Captain]
9a.: [Xanadu EOC]
9b.: [Xanadu Fire Station 14]
10.: [Equipment Status]
12.: [All equipment is ready for deployment]
Rec-Sent: [sender]
OpCall: [W6XRL4]
OpName: [Herman Munster]
Method: [Other]
Other: [Packet]
OpDate: [10/09/2023]
OpTime: [20:17]
!/ADDON!

(#1) >

```

PackItForm Home Page

File Edit View History Bookmarks Tools Help

SCCo PackItForms X14-312M_R_IC213_Equipment Sta X

127.0.0.1:64874/manual 110%

Santa Clara County ARES/RACES PackItForms

Setup Edit ICS-309 Log

Create a message to send

Message type: XSC ICS-213 Message

Create Message

View a received message

Enter the received message, including the From, Subject and other header, drag and drop or upload a file.

Message:

9a.: [Xanadu EOC]
 9b.: [Xanadu Fire Station 14]
 10.: [Equipment Status]
 12.: [All equipment is ready for deployment]
 Rec-Sent: [sender]
 OpCall: [W6XRL4]
 OpName: [Herman Munster]
 Method: [Other]
 Other: [Packet]
 OpDate: [10/09/2023]
 OpTime: [20:17]
 !/ADDON!

Received Date: 10/09/2023 Time: 20:41

Log and View Reset Fields

1. Receive a packet message

Suppose at XNDEOC... Outpost shows the same error.

1. Connect to the BBS with PuTTY and retrieve a message
2. List the messages with **LM**
3. Read the message with **R #** (message number)

You recognize Message #1 is a PackItForm message

4. Highlight all text from **Date:** to **!/ADDON!** (inclusive)
 - In PuTTY, selecting text copies it to the clipboard

NOTE: This manual process handles both *PackItForms* and *plain text* messages. Both can be processed by pasting them into the Home Page.

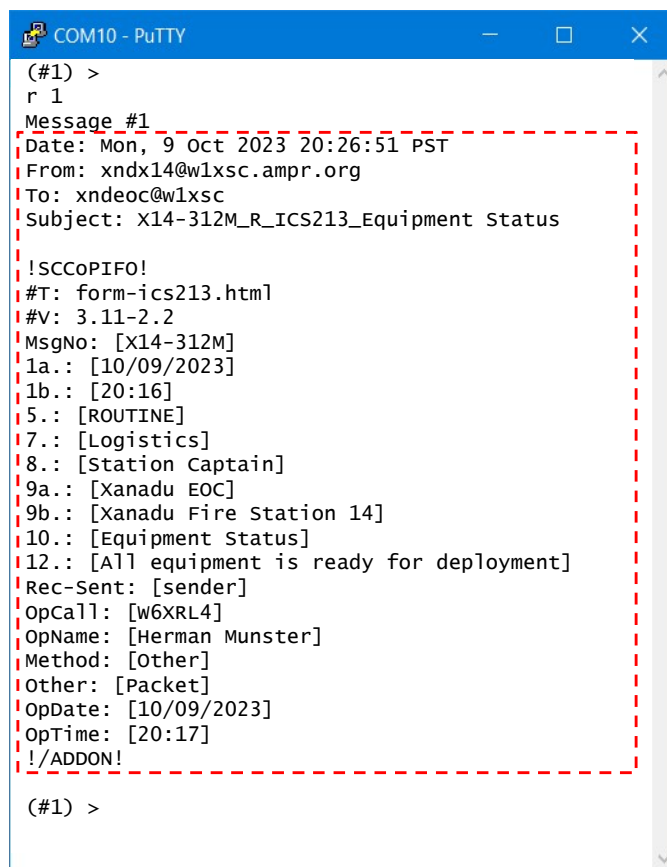

```

COM10 - PuTTY
(#1) >
r 1
Message #1
Date: Mon, 9 Oct 2023 20:26:51 PST
From: xndx14@w1xsc.ampr.org
To: xndeoc@w1xsc
Subject: X14-312M_R_IC213_Equipment Status

!SCCoPIFO!
#T: form-ics213.html
#V: 3.11-2.2
MsgNo: [X14-312M]
1a.: [10/09/2023]
1b.: [20:16]
5.: [ROUTINE]
7.: [Logistics]
8.: [Station Captain]
9a.: [Xanadu EOC]
9b.: [Xanadu Fire Station 14]
10.: [Equipment Status]
12.: [All equipment is ready for deployment]
Rec-Sent: [sender]
OpCall: [W6XRL4]
OpName: [Herman Munster]
Method: [Other]
Other: [Packet]
OpDate: [10/09/2023]
OpTime: [20:17]
!/ADDON!

(#1) >
  
```

2. Recover the PackItForm message

Home Page

Back at the Browser, get back to the SCCo PackItForms tab

5. Put your cursor in the “View a received message” section, and enter **<ctrl>V** or **Edit > Paste** to paste in the received message.
6. Press **Log and View**.
 - This entry is logged to the ICS 309
 - The received PackItForm is opened in its PackItForm.
7. Once the PackItForm is opened, print and hand it off for delivery.

File Edit View History Bookmarks Tools Help

SCCo PackItForms X14-312M_R_ICCS213_Equipment Sta X

127.0.0.1:64874/manual 110%

Santa Clara County ARES/RACES PackItForms

Setup Edit ICS-309 Log

Create a message to send

Message type: XSC ICS-213 Message

Create Message

View a received message

Enter the received message, including the From, Subject and other header
drag and drop or upload a file.

Message:

9a.: [Xanadu EOC]
 9b.: [Xanadu Fire Station 14]
 10.: [Equipment Status]
 12.: [All equipment is ready for deployment]
 Rec-Sent: [sender]
 OpCall: [W6XRL4]
 OpName: [Herman Munster]
 Method: [Other]
 Other: [Packet]
 OpDate: [10/09/2023]
 OpTime: [20:17]
 !/ADDON!

Upload

Download

Received Date: 10/09/2023 Time: 20:41

Log and View Reset Fields

© Copyright 2011-2023 Santa Clara County ARES®/RACES. All rights reserved.

3. Save this PackItForm message

8. Back at the **Home Page** , Press the **Download** button. The **Message Page** opens and shows the message text.
9. Put your mouse cursor in the text area, and then:
 - From the browser menu, **File > Save As**
 - **-- Or --**
 - **<ctrl>-s** (same as menu)
10. Navigate to the PackItForm save directory previously created. The file name is set to the Subject.
11. Press **Save**.

The screenshot shows a web browser window with the URL 127.0.0.1:64874/manual. The page title is 'Santa Clara County ARES/RACES PackItForms'. The interface includes a menu bar (File, Edit, View, History, Bookmarks, Tools, Help) and a toolbar with 'Setup' and 'Edit ICS-309 Log' buttons. The main content area is divided into two sections: 'Create a message to send' and 'View a received message'. The 'View a received message' section contains a text area with the following message content:

```

Message:
0a.: [Xanadu EOC]
0b.: [Xanadu Fire Station 14]
10.: [Equipment Status]
11.: [All equipment is ready for deployment]
Rec-Sent: [sender]
OpCall: [W6XRL4]
OpName: [Herman Munster]
Method: [Other]
Other: [Packet]
OpDate: [10/09/2023]
OpTime: [20:17]
!/ADDON!
  
```

Below the message text, there are 'Upload' and 'Download' buttons. The 'Download' button is highlighted with a red box, and a red arrow points from the 'Download' button in the instructions to this button. At the bottom of the page, there are fields for 'Received Date: 10/09/2023' and 'Time: 20:41', along with 'Log and View' and 'Reset Fields' buttons.

© Copyright 2011-2023 Santa Clara County ARES®/RACES. All rights reserved.

Sidebar: A Note on Outpost tags

- Messages sent from Outpost occasionally have “tags” inserted in messages that you might see.
- Some of the more common tags are:
 - !RRR! Request Read Receipt
 - !RDR! Request Delivery Receipt
 - !SCCoPIFO! This is a PackItForm message
 - !/ADDON! The end of a PackItForm or other Addon message
 - !UG! Mark message as urgent (lists as RED in the Outpost listing)
- PackItForms will ignore many Outpost tags that it sees and they will not show up in the message.

What about the saved messages?

- Take a look at your **C:\MyMessage\X14-23-1009T** manual message directory (or whatever you named it).
- The message's Subject field is used for the file name.
- Clicking on the "Name" column header sorts messages by file name.
- Clicking on the "Date Modified" column header sorts by file timestamp.
- These views can help with managing your messages.
- Submit this directory with your paperwork when done.

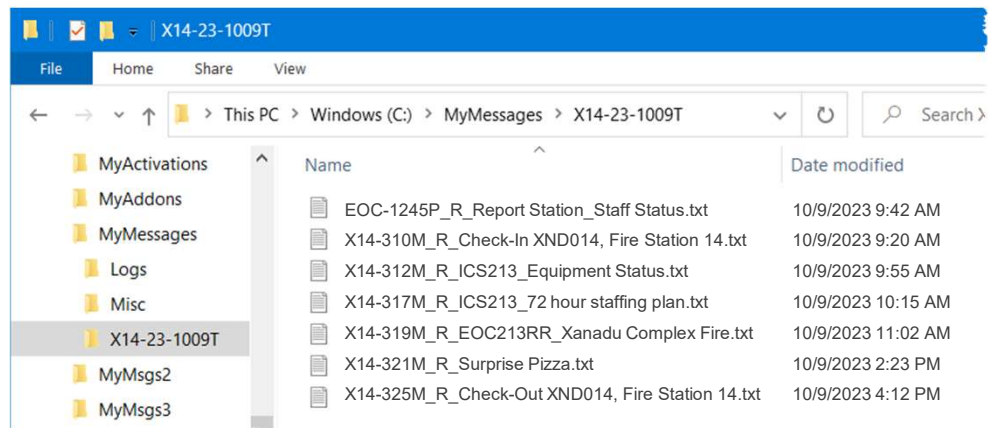

What about the ICS 309?

- Manual PackItForms comes with its own ICS 309 Log, similar to what Outpost does.
- From the PackItForm **Home Page**, when you click on **Log and View** , you write a new ICS 309 Log entry for this message.
- From the PackItForm **Home Page**, when you click on **Edit ICS-309 Log** , you open the ICS 309 form for editing and printing.

What about the ICS 309?

- All fields are editable.
- Required fields are highlighted in RED.



Trash Can symbol deletes the entry.



Plus symbol adds another line for a manual entry.

- **Erase All** – clears the form, does not require a **Save** to commit the changes.
- **Download...** – creates a .csv file of the Comm Log.
- **Print** – prints the Comm Log to the selected printer.
- **Save** – Saves any changes you made.

COMM Log ICS 309-SCCo ARES/RACES

1. Incident Name and Activation Number

2. Operational Period (Date/Time)

From: m/d/yyyy hh:mm To: m/d/yyyy hh:mm

3. Radio Net Name (for NCOs) or Position/Tactical Call

4. Radio Operator (Name, Call Sign)

call-sign

Time (24:00)	FROM		TO		Message	Icons
	Call Sign/ID	Msg #	Call Sign/ID	Msg #		
13:49	XND022	X22-121M	XNDEOC@w1 ...		R_Check-In XND022, Kios ..	🗑️ +
14:27	XND022	X22-123M	XNDEOC@w1 ...		R_IC213_Opening Status	🗑️ +
14:41	xndeoc@w1 ...	XND-3001P	XND022	X22-124M	R_IC213_opening status ..	🗑️ +
15:13	xndeoc@w1 ...	XND-2009P	XND022	X22-126M	R_IC213_4-hour festiva ..	🗑️ +
15:33	XND022	X22-127M	XNDEOC@w1 ...		I_EOC213RR_XANADU PICNI ..	🗑️ +

6. Prepared By (Name, Call Sign)

6A. Signature

7. Date & Time Prepared

m/d/yyyy hh:mm

ICS 309-SCCo ARES/RACES (Rev. 2021-Apr-08) PIF: 1.0

Erase All **Download CSV File** **Print** **Save**

© Copyright 2011-2023 Santa Clara County ARES®/RACES. All rights reserved.

Manual packet operations; not many changes

This is a tool change, not a process change

- 1. First Shift...**
 - a. Show up, request a safety and assignment briefing
 - b. Find a workspace for your packet operations
- 2. Initial station setup...**
 - a. Find, assess, and set up the packet station
 - b. equipment check-out
- 3. Packet Operations...**
 - a. Download notices, send yourself a test message
 - b. Send the formatted check-in message with your Tac Call
 - c. Manage the message flow
- 4. Incoming Shift Change...**
 - a. Request a safety and assignment briefing
- 5. Outgoing Shift Change...**
 - a. Archive the event documentation
- 6. Securing Operations...**
 - a. Send the formatted check-out message with your Tac Call
 - b. Archive the event documentation
 - c. Shutdown

© Copyright 2011-2023 Santa Clara County ARES®/RACES. All rights reserved.

102

Amateur Packet Radio Field Reference, Type II

- Taking a quick look inside

Table of Contents

- 1 QUICK REFERENCE.....
- 2 INTRODUCTION.....
 - 2.1 PURPOSE.....
 - 2.2 HOW TO USE THIS HANDBOOK.....
 - 2.3 OTHER REFERENCES.....
- 3 MANUAL PACKET OPERATIONS.....
 - 3.1 TNC COMMANDS.....
 - 3.2 BBS COMMANDS.....
 - 3.3 CONNECTING TO THE TNC WITH PUTTY.....
 - 3.4 START OF SHIFT: CONFIGURE TNC SETTINGS.....
 - 3.5 END OF SHIFT: RESTORE TNC SETTINGS.....
 - 3.6 GETTING READY FOR MANUAL MESSAGING.....
 - 3.7 MANUAL MESSAGE BASICS.....
 - 3.8 SENDING A PACKITFORM MESSAGE MANUALLY.....
 - 3.9 RECEIVING A PACKITFORM MESSAGE MANUALLY.....
 - 3.10 VIEWING SAVED MESSAGES.....
 - 3.11 NOTES ON MANUAL ICS 309 COMM LOG.....

(the unofficial)
**Amateur Packet Radio
Field Reference, Type II**

For SCCo RACES Responders

November 2023



Could manual packet ops really happen to me?

- Better to be safe than sorry... Build your USB packet thumb-drive now!



- Directories (suggested)
 - x:\Programs
 - Putty installer (<https://www.putty.org/>)
 - Putty standalone executables (<https://www.putty.org/> > Alternative binary files)
 - SCCo PackItForm Directory (C:\PackItForms\Outpost\SCCo)
 - SCCo Packet Installer - <https://www.scc-ares-races.org/data/packet/client-software.html>
 - SCCo PIFO only Installer (<download_dir>\sccsetup162Mpub_includes\SccoPIFOsetup3.13pub.exe)
 - Office Libre Portable version (<https://www.libreoffice.org/download/portable-versions/>)
 - x:\SCC Notices
 - downloaded text version
 - Archive of the Outpost SCC Notices directory to reload if necessary
 - x:\TNC Init files
 - text version, seven total
 - x:\Docs
 - Too many to list here... (<https://www.scc-ares-races.org/data/packet/index.html>)
 - Unofficial Amateur Packet Radio Field References, Type III, Type II, e-book edition
 - x:\Miscellaneous
 - Pre-defined messages to be edited prior to sending
 - x:\MyMessages\<event>
 - Or whatever directory name you choose.

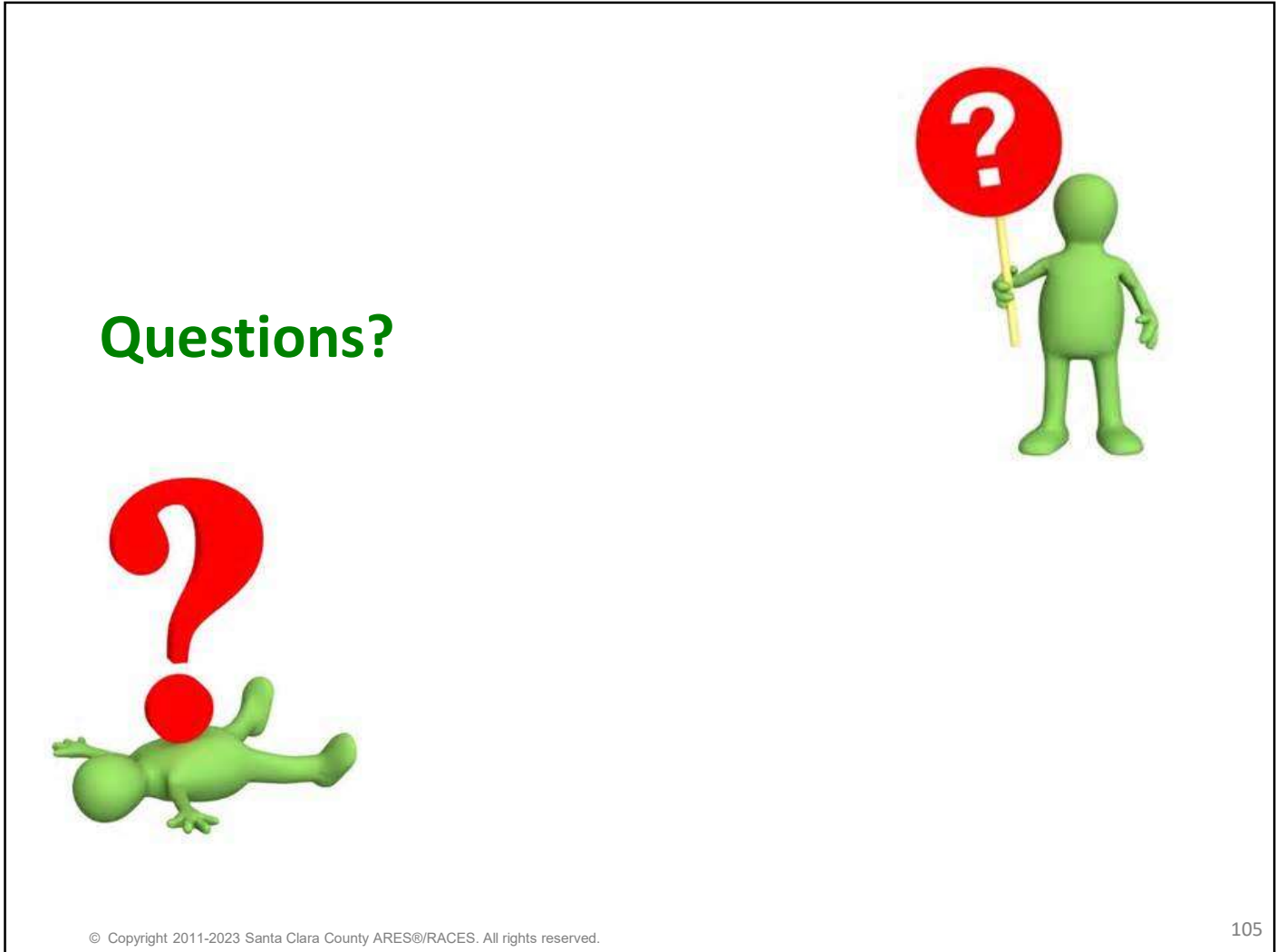

WRAP UP

© Copyright 2011-2023 Santa Clara County ARES®/RACES. All rights reserved.

106

106

First things first

- Online Class Evaluation

- Log into <https://www.scc-ares-races.org/activities/events.php>
Click “Submit Class Evaluation” in Events

Home
[Log Out](#)
[Activities Home](#)
[SCC ARES/RACES Home](#)
[Comments/Bugs](#)
Events
[List Events By Date](#)
[List Events I Joined](#)
[Create a New Event](#)
[Modify an Event](#)
[Delete an Event](#)
[List/Print an Event Roster](#)
[Log Event Participation](#)
[Submit Class Evaluation](#)
My Profile

Calendar of Events
 Show: Current events Past events Event Descriptions

Packet Operations - Type II - Adv / Troubleshooting

Date:	Start:	Type:	Credential C
11/04/23	9:00 AM	County Training	Yes

Course Details: Click here to visit the course description and download the ele...

EC/AEC Council Meeting

Date:	Start:	Type:	Credential C
11/09/23	7:00 PM	Other Meeting	No

Purpose: Discuss organizational and management ideas, strategies, best pr

- Submit your evaluation as soon as possible... after 1 week, the form will no longer be available for this class!

Exercise Scenario

- You've been dispatched by the *Xanadu EOC* to provide communications for a field location.
 - The EOC's tactical call is XNDEOC on W1XSC.
 - Your tactical call is: XND### (Assigned by your instructor)
 - Your Message Prefix: X##
 - Your assignment Name: Xanadu Post ##
 - Operate using your home city's primary or secondary BBS.
- You arrive at your assignment and set up the station, but discover that Outpost on the packet PC does not work! Looks like you need to do all packet operations manually.
- Your assignment will be mailed to you ahead of time.

Where "##" are the last two digits of your tactical call

Thank You!

Please complete the Course Evaluation
on or before next Saturday 11-November!

Please complete the Assignment
on or before next Saturday 11-November!

Office Hours:

Sunday, 5 November, 3:00p to 5:00p (zoom)
Wednesday, 8-November, 7:30p to 9:00p (zoom)

If you have questions or feedback about this or other training activities,
you can join our packet discussion group.

<https://scc-ares-races.groups.io/g/packet>

Questions, comments, suggestions?

kn6pe@arrl.net